



FINISHING SECTIONS

EXANGLE®

RONDO®

RONDO EXANGLE® DRYWALL FINISHING SECTIONS

SUMMARY

The EXANGLE® range of building board finishing profiles are designed to give plasterers a clean, defined edge on straight or curved details for internal building board applications.

SUITABLE FOR:

- Internal and External Corners
- Shadowline applications
- Flashing in wet areas
- Archways
- Control Joints
- Edge capping
- Bullnose corners

SPECIAL FEATURES

- Choice of perforated or Expanded profiles
- Nail holes on selected profiles for easy installation
- Minimum coating of Z200
- Made from 0.30-0.50BMT Galvabond or Zincanneal Steel to provide ideal stiffness

IN PRACTICE

The Rondo EXANGLE® range of profiles are used in many leading projects to complete the wall and ceiling linings. This includes *City Square in Perth* where our P50 Shadowline Stopping Angle was installed on 45 levels of the building and the *Royal Children's Hospital in Melbourne* where 440,000 metres of EXANGLE® finishing sections were used to construct this world-class project.

IMPORTANT NOTE:

Rondo recommends its products and systems are installed by a qualified tradesperson and according to the relevant codes and standards outlined on page 256 of this manual.

CONTENTS:

FINISHING SECTIONS	168
APPLICATION DETAILS:	
• CORNER BEADS	170
• ARCH BEADS & STOPPING BEADS	171
• STOPPING ANGLES	172
• SHADOWLINE COMBINATION SET BEAD	173
• CASING BEADS	174
• CONTROL JOINTS	175
• INTERNAL ANGLES	176
• BULLNOSE SECTIONS	177
INSTALLATION DETAILS:	
• FINISHING SECTIONS	178
• ARCH BEADS	179
• P35 CONTROL JOINT	179



RONDO EXANGLE FINISHING SECTIONS

EXTERNAL CORNER BEADS

P01	90° Mini Bead Perforated 30mm
P01A	135° Mini Bead Perforated 30mm
P32	90° Expanded Corner Bead 32mm

EXTERNAL CORNER BEADS

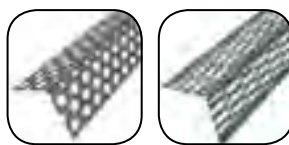

P01/P01A

P32

INTERNAL CORNER BEADS

PS17	90° Mini Bead Internal
PS1A	135° Mini Bead Internal

INTERNAL CORNER BEADS



PS17/PS1A

ARCH BEADS



P10

ARCH BEADS

P10	Perforated arch bead
-----	----------------------

PLASTER STOPPING BEADS

P11	6mm Board Stopping Bead
P12	10mm Board Stopping Bead
P13	13mm Board Stopping Bead
P14	16mm Board Stopping Bead

PLASTER STOPPING BEADS



P11/P12/P13/P14

PLASTER STOPPING ANGLES

P25	10mm Long Leg
P26	13mm Long Leg
P27	16mm Long Leg
P28	32mm Long Leg

PLASTER STOPPING ANGLES

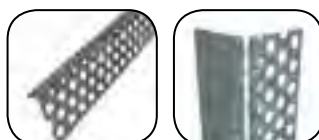

P25/P26/P27

P28

SHADOWLINE STOPPING ANGLES

P50	10mm Shadowline Stopping Angle for 10/13/16mm Board
P60	10mm Shadowline Stopping Angle for 6mm Board
P50R	10mm Shadowline Stopping Angle for 10/13/16mm Board Radiused
P51	Shadowline Combination Set Bead for 10mm Board
P52	Shadowline Combination Set Bead for 13mm Board
P53	Shadowline Combination Set Bead for 16mm Board

SHADOWLINE STOPPING ANGLES

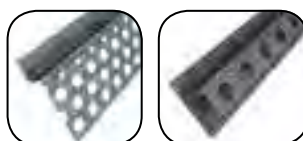

P50/P60

P51/P52/P53

PLASTER INTERNAL ANGLES

P18	28 x 28mm Internal Angle
P40	40 x 40mm Internal Angle

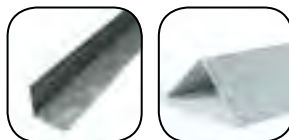

P18

P40

SHADOWLINE CASING BEADS

P06	10mm Shadowline Casing Bead for 10mm Board
P09	10mm Shadowline Casing Bead for 13mm Board

SHADOWLINE CASING BEADS



P06/P09

PLASTER CASING BEADS

P03	6mm board casing bead
P05	10mm board casing bead
P07	13mm board casing bead
P08	16mm board casing bead

PLASTER CASING BEADS



P03/P05/P07/P08

EXPANSION JOINT

P35	Plasterboard Expansion Joint for Board Thicknesses more than 10mm
-----	---

EXPANSION JOINT

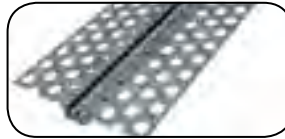

P35

BULLNOSE SECTIONS

R05	10mm Radius Bullnose Corner Bead
R06	22mm Radius Bullnose Corner Bead

BULLNOSE SECTIONS



R05/R06

TYPICAL APPLICATION DETAILS

Corner Beads

P01 90° & P01A 135° (EXTERNAL)

A lower profile nib on the P01 bead reduces the compound build up on the corner and assists in reducing skirting board or reveal kick-out. The Rondo EXANGLE® P01 corner bead has perforated metal wings angled at 84° to allow the setting compound to penetrate through and under the bead.

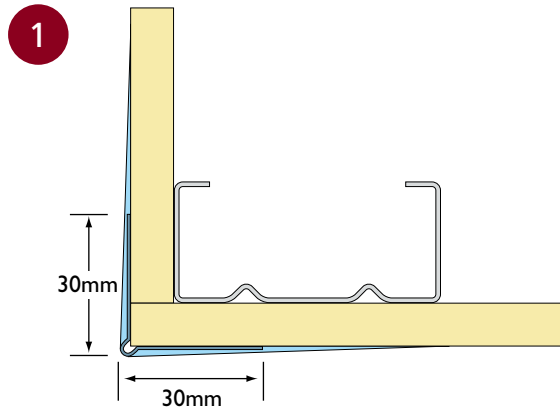
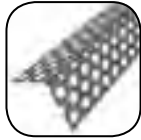

■ EXTERNAL CORNER BEAD DETAIL

P32 90° (EXTERNAL)

Rondo P32 expanded corner bead has a slightly larger nib than the P01 at 3mm and the expanded metal wings allow more compound penetration for situations where a stronger, more stable corner treatment is required.

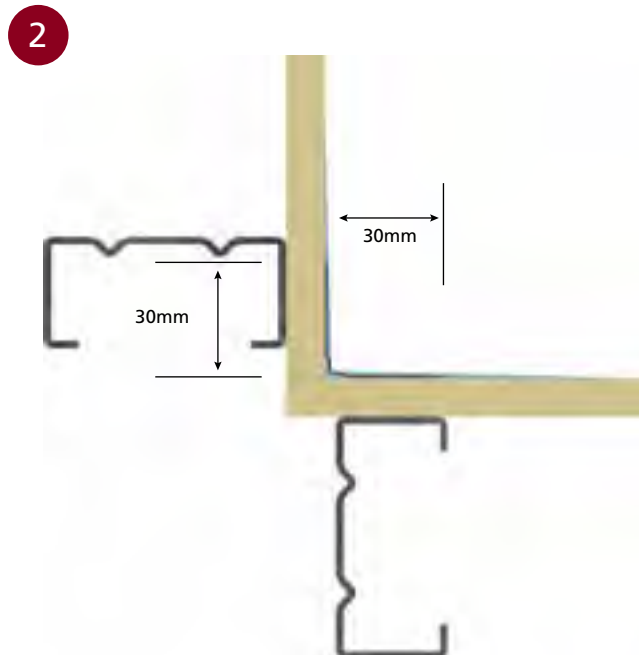

■ INTERNAL CORNER BEAD DETAIL

PS17 90° & PS1A 135° (INTERNAL)

The original Rondo EXANGLE® internal corner bead was designed for use with fibrous plaster sheets to enable the internal corner to be straightened and neatly finished, ready for painting. The redesign of this product to suit modern building boards has resulted in stronger, straighter, crack-free internal corners being produced ready for painting. The flat surface at the centre of the bead which is raised up at 90° from the perforated section, provides a guide for the setting trowel. The small holes along the inner edge of the 90° raised section allows the setting compound to bond to both the internal and external surface of the bead, reducing the potential for cracking in both horizontal and vertical applications.

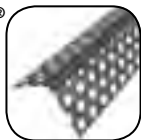

	APPROX WEIGHT PER LINEAL METRE (kg)	MATERIAL THICKNESS (BMT)	STD LENGTHS (metres)	MATERIAL SPECIFICATIONS
P01	0.116	0.40	2.4, 2.7, 3.0, 3.6	G2 GALVABOND Z200
P01A	0.116	0.40	3.0	
PS17/PS1A	0.116	0.40	3.0	

Arch Beads & Stopping Beads

P10 ARCH BEAD

Designed for use with the P01 corner beads, as it has the same nib profile and leg length.

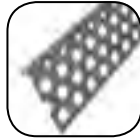

When installing arch beads, care should be taken not to bend it into a radius too quickly. It should be a gradual process starting at one end, gradually bending around the building board finished frame.

The long leg of the arch bead is fixed to the inside of the arch profile for painting. The flat raised surface at the centre of the bead which is raised up at 90° from the perforated section, provides a guide for the setting trowel. The small holes along the inner edge of the 90° raised section allows the setting compound to bond to both the internal and external surface of the bead, reducing the potential for cracking in both horizontal and vertical applications.

3

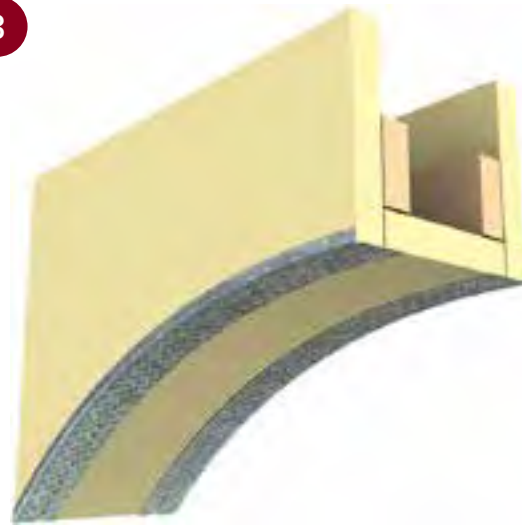

■ ARCH BEAD: TYPICAL APPLICATION

P11/P12/P13/P14 STOPPING BEADS

The Rondo stopping beads are suitable for building boards of 6mm to 16mm thickness. The finishing coats are applied up to the nib, which is blended back into the sheet.



4

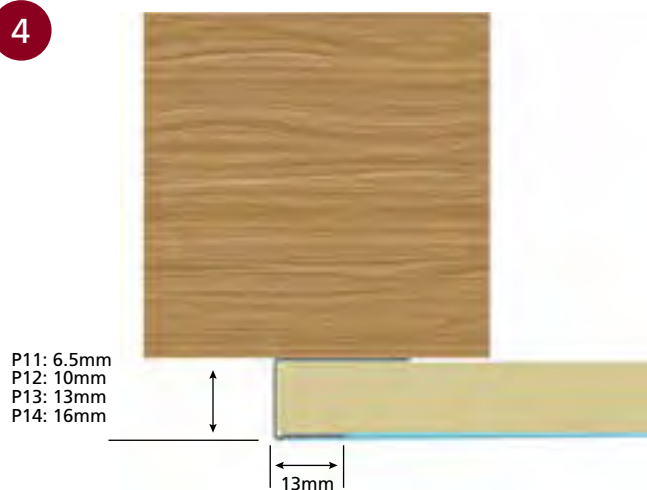

■ STOPPING BEAD DETAIL

	APPROX WEIGHT PER LINEAL METRE (kg)	MATERIAL THICKNESS (BMT)	STD LENGTHS (metres)	MATERIAL SPECIFICATIONS
P10	0.080	0.35	3.0	G2 GALVABOND Z200
P11	0.133	0.40	3.0	
P12	0.133	0.40	3.0	
P13	0.133	0.40	3.0	
P14	0.173	0.40	3.0	

TYPICAL APPLICATION DETAILS (continued)

Stopping Angles

P25/P26/P27/P28

Plaster Stopping Angles have a perforated, recessed edge and are used where the edge of the building board is not exposed and where the fitting of a Stopping Bead would be difficult.

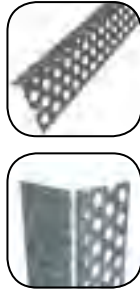

The Stopping Angle is fixed to the sheet of building board with an adhesive or staples, with the finishing coats bonding into the building board and feathering up to the bead nib. Ideal for use around door jambs, however, in this application it is recommended that when using building board up to 10mm thick, a P26 should be used so that the leg will slot into the door jamb as shown. Similarly, when using 13mm board, P27 should be used.

5

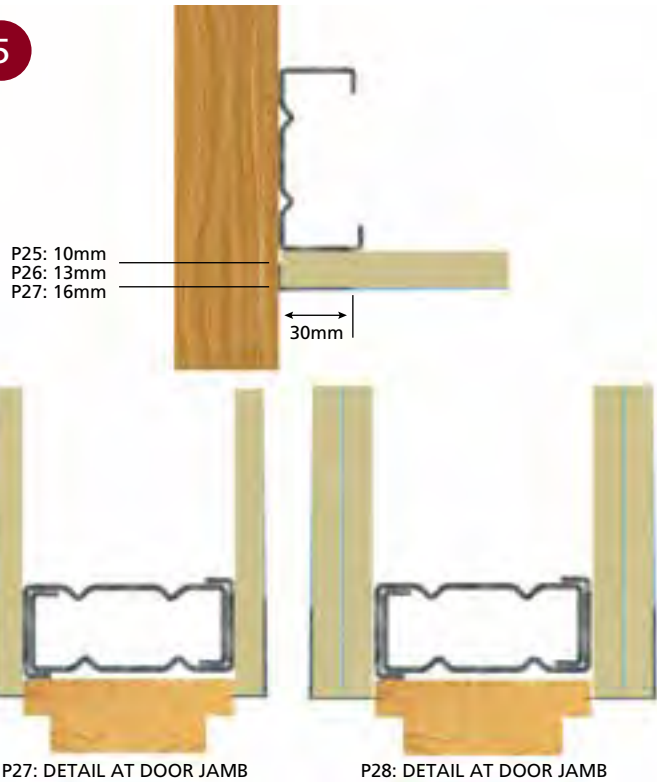

■ STOPPING ANGLE DETAIL

P50/P60

Shadowline Stopping Angles are the professional section for minimising the appearance of 'out of align' walls and ceilings by giving a clean, straight, shadow edge after setting.



Shadowline stopping angles are suitable for vertical, horizontal and curved applications and are ideal for use around ceiling perimeters, door jambs, windows and lift openings.

6

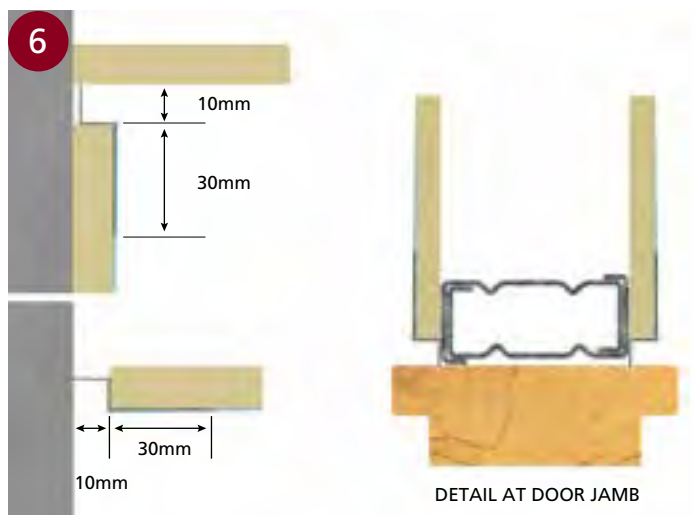

■ SHADOWLINE STOPPING ANGLE DETAIL

	APPROX WEIGHT PER LINEAL METRE (kg)	MATERIAL THICKNESS (BMT)	STD LENGTHS (metres)	MATERIAL SPECIFICATIONS
P25	0.010	0.40	3.0	G2 GALVABOND Z200
P26	0.124	0.40	3.0	
P27	0.133	0.40	3.0	
P28	0.175	0.40	3.0	
P50	0.138	0.40	3.0	
P60	0.124	0.40	3.0	

Shadowline Combination Set Bead

P51/P52/P53

Shadowline stopping beads enable negative details to be easily formed around the perimeter of



ceilings when used in combination with Rondo 140 Furring Channel Track. The shadow detail creates the impression of greater ceiling heights whilst helping to hide imperfections in the abutting walls.

It is also an ideal product for forming shadow details at the top of steel stud partition walls by slipping the bead onto the legs of the wall track before inserting the plasterboard.

Slipping the shadow bead onto the edge of the plasterboard sheets enables clean negative details to be produced around door jambs, window frames, lift openings or where other negative details would enhance the appearance of a junction or opening.

The P51 is designed for use with 10mm plasterboard, while the P52 is designed for 13mm plasterboard and P53 suits 16mm plasterboard. The profiled nib and perforated leg enable a good bonding key between the compound and plasterboard.

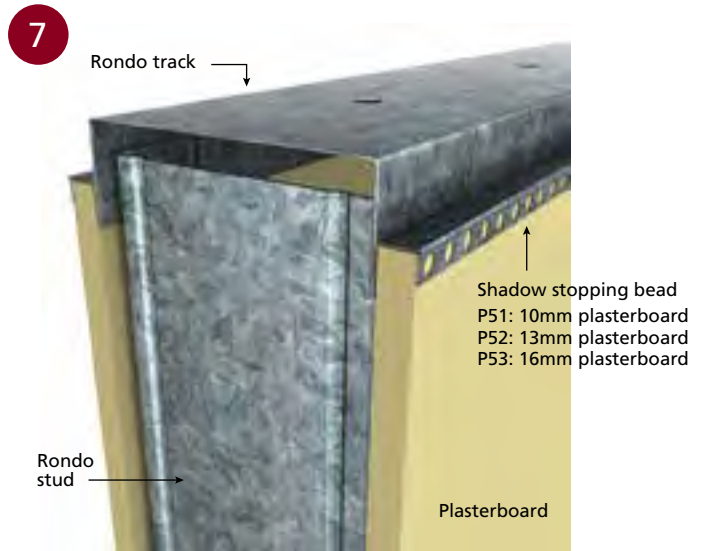

■ SHADOW STOPPING BEAD: TYPICAL APPLICATION

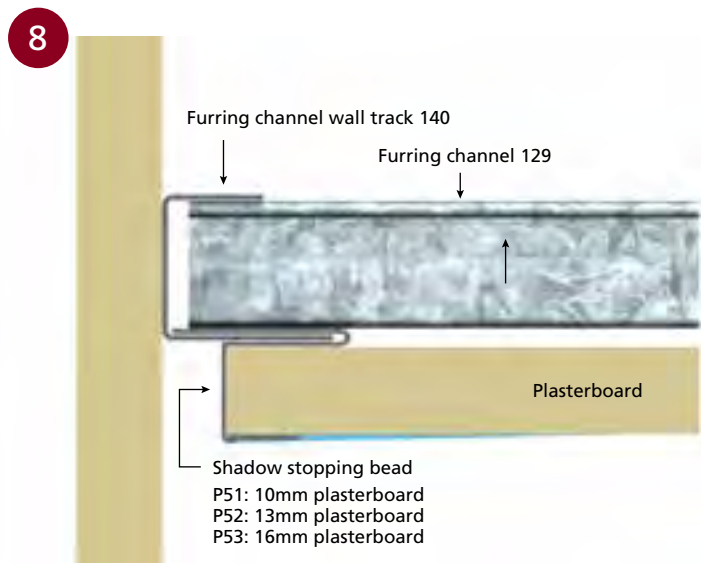

■ SHADOW SET DETAIL

	APPROX WEIGHT PER LINEAL METRE (kg)	MATERIAL THICKNESS (BMT)	STD LENGTHS (metres)	MATERIAL SPECIFICATIONS
P51	0.276	0.40	3.0	G2 GALVABOND Z200
P52	0.283	0.40	3.0	
P53	0.300	0.40	3.0	

TYPICAL APPLICATION DETAILS (continued)

Casing Beads

P03/P05/P07/P08

Casing beads are square cornered metal beads that fit snugly over the edge of the building board for protection at abutments, no setting is required. Rondo casing beads are manufactured from 0.5mm ZINCANNEAL™ material, and are easily painted on site.

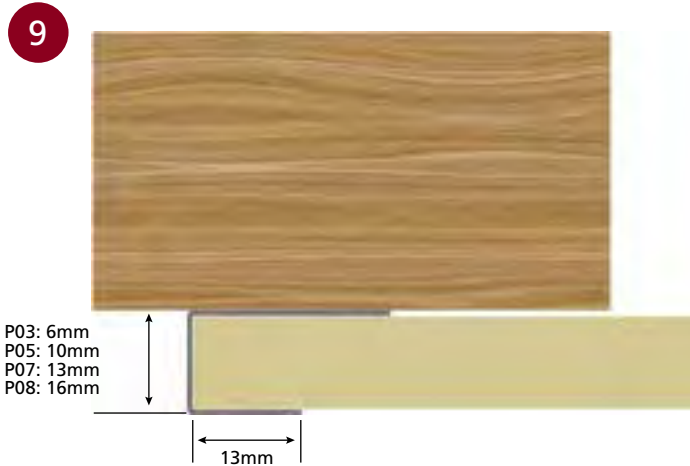

■ CASING BEAD DETAIL

P06/P09

When the Rondo EXANGLE® Shadowline casing bead is fitted to the edge of building boards, a neat shadowline is achieved as the bead comes into contact with the other abutments. The shadow that is created assists in hiding imperfections in the wall alignment, and also gives a very pleasing result around door jambs. No setting is required. Both the P06 and P09 are manufactured from ZINCANNEAL™ and are easily painted on site.

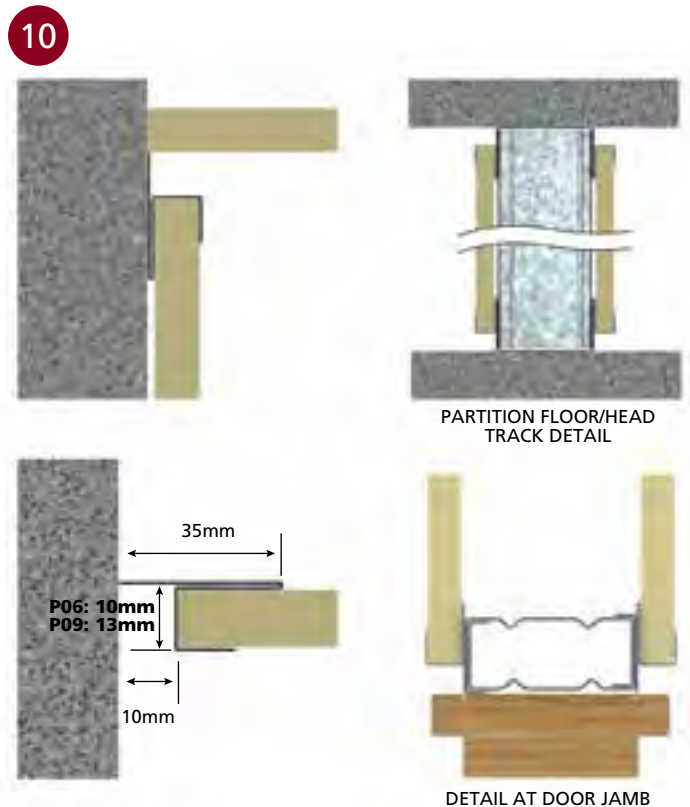

■ SHADOWLINE CASING BEAD DETAIL

	APPROX WEIGHT PER LINEAL METRE (kg)	MATERIAL THICKNESS (BMT)	STD LENGTHS (metres)	MATERIAL SPECIFICATIONS
P03	0.202	0.50	3.0	ZINCANNEAL
P05/P07	0.202	0.50	3.0, 3.6	
P08	0.327	0.50	3.0	
P06	0.216	0.55	3.0	
P09	0.382	0.55	3.0	

Control Joints

P35

The Rondo EXANGLE® P35 Control Joint has a specially designed PVC rubber flexible joint



which locks onto two galvanised (Z200) setting beads.

A protective filament tape is attached to the flexible joint section to keep it clean when applying the setting compound, and is removed on completion. Used in both stud walls and flush building board ceilings, the P35 has been designed for movement of up to 5mm in each direction.

PVC is inherently flame resistant in the sense that if the source of the flame is removed, it will self-extinguish. The P35 has been approved for use in fire rated walls and ceilings. (See *building board manufacturer's installation details.*)

This pre-assembled, ready to use Control Joint has been designed for interior use only and when finished leaves a straight, low profile reveal.

Control joints should be placed as recommended by the building board manufacturer for both ceilings and walls, or where Control Joints occur in the building structure. Control joints should also be used where dissimilar building materials are joined to allow for differential movement in the materials.

11

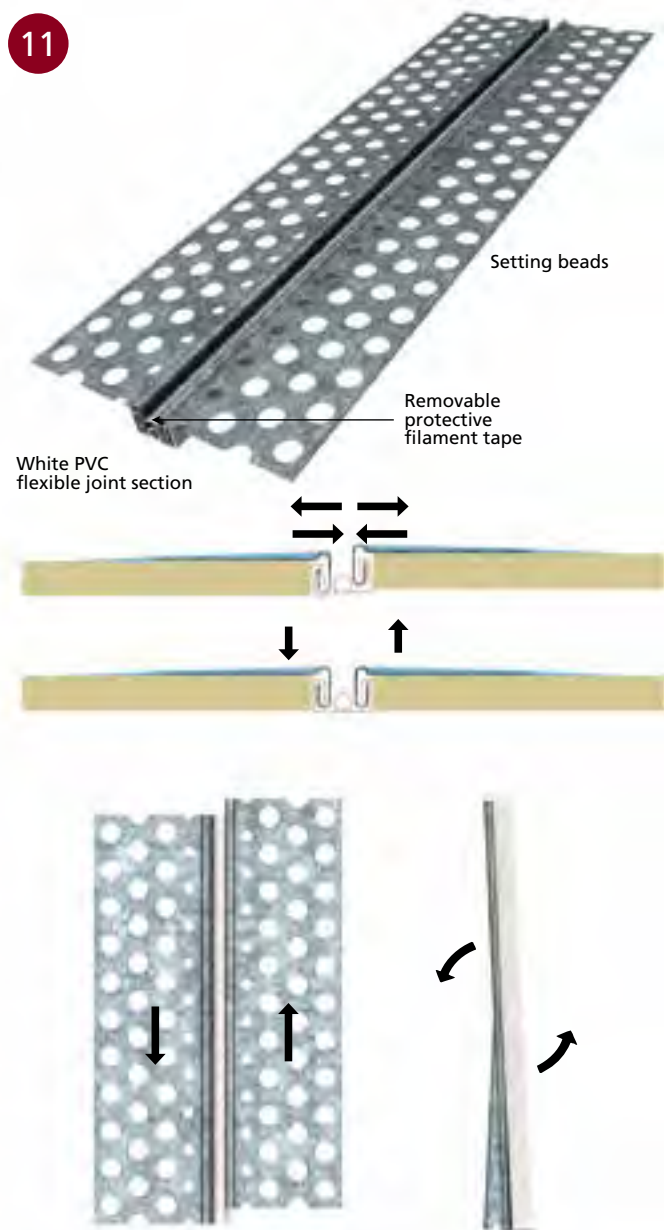

■ P35 CONTROL JOINT

	APPROX WEIGHT PER LINEAL METRE (kg)	MATERIAL THICKNESS (BMT)	STD LENGTHS (metres)	MATERIAL SPECIFICATIONS
P35	0.345	0.40	3.0	G2 GALVABOND Z200

TYPICAL APPLICATION DETAILS (continued)

Internal Angles

P18

The Rondo EXANGLE® internal corner angle is used behind the building board at the intersection of timber walls (see Figure 12) to add strength and eliminate the cracking of the internal corner. The light gauge of the material makes it easy to nail to timber studs.



12

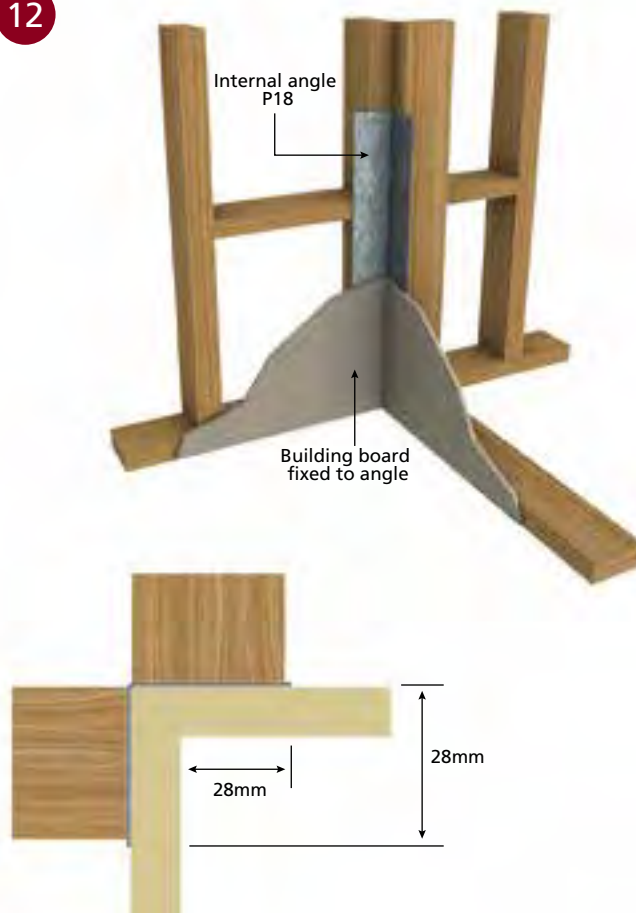

■ P18 TYPICAL APPLICATION

P40

Australian Standard AS3740–2010 (*Waterproofing of Wet Areas within Residential Buildings*), requires an internal corner section with a minimum 40mm width either side of a board junction in wet areas. The Rondo EXANGLE® P40 Internal Stabilising Angle should be fixed to timber framed junctions in wet areas at a minimum of 1800mm above the floor level to provide support behind the lining board corner junction (see Figure 13).



13

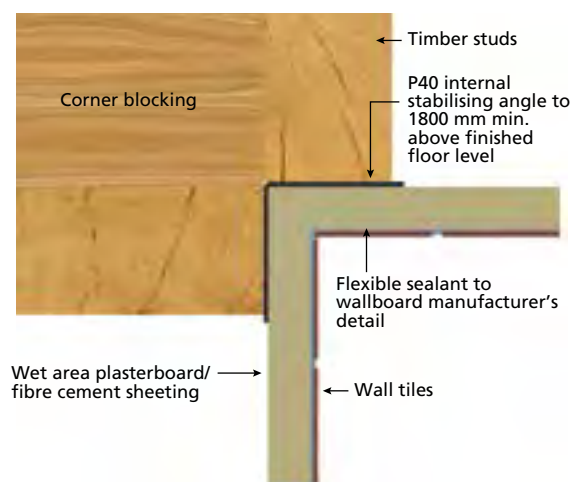

■ P40 DETAIL

	APPROX WEIGHT PER LINEAL METRE (kg)	MATERIAL THICKNESS (BMT)	STD LENGTHS (metres)	MATERIAL SPECIFICATIONS
P18	0.121	0.30	2.4	ZINCALUME
P40	0.163	0.30	1.8	

Bullnose Sections

R05/R06

Bullnose corner beads were designed for the commercial building trade for use in high traffic areas such as hospitals, schools, and public buildings. In recent times, designers of quality homes have found it useful where a softer look is required.



Bullnose sections are manufactured from ZINCANNEAL™ steel, and are easily painted on site.

INSTALLATION: SINGLE LAYER

STEP ONE

Fix 10 or 13mm plasterboard 7mm back from the corner.

STEP 2.

Fix the Bullnose Section onto the corner ensuring that the stopping edges bear on the plasterboard (see Figure 14).

INSTALLATION: DOUBLE LAYER

STEP ONE

Fix 10 or 13mm plasterboard in line with the corner.

STEP 2.

Fix the Bullnose Section onto the corner ensuring that the stopping edges bear on the plasterboard.

For 16mm plasterboard, fix as per double layer application (see Figure 15).

14

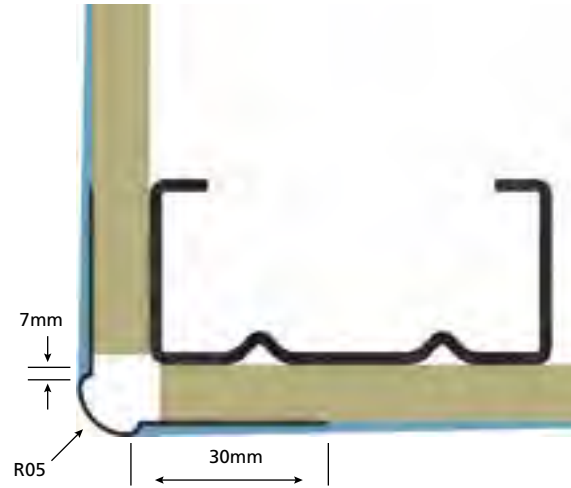

■ R05 INSTALLATION DETAIL

15

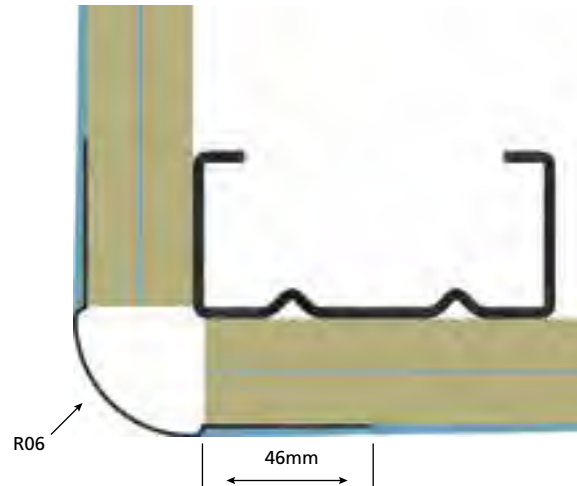

■ R06 INSTALLATION DETAIL

	APPROX WEIGHT PER LINEAL METRE (kg)	MATERIAL THICKNESS (BMT)	STD LENGTHS (metres)	MATERIAL SPECIFICATIONS
R05	0.228	0.55	3.0	ZINCANNEAL
R06	0.412	0.55	3.0	

INSTALLATION DETAILS

Finishing Sections

STEP ONE



Beads can be attached by nails or a staple gun at not more than 500mm centres down the legs of the bead, and not more than 100mm from each end.

STEP TWO



Using a 100mm broad knife, apply setting compound to the bead to a width of approximately 100mm each side of the corner, filling all perforations. Allow to dry, then remove any excess and lightly sand if necessary.

STEP THREE



Apply second coat to a width of approximately 120mm. Allow to dry, then remove any excess and lightly sand if necessary.

STEP FOUR



Apply third coat with a 200mm broad knife. Feather edges with a wet paint brush. Allow to dry.

STEP FIVE



Using sandpaper and sanding float, gently sand the dry joints to a smooth even finish. Hold the float diagonally across the joint, taking care not to scuff the paper face of the building board where it meets the setting compound.

NOTE:

The Australian Standard for the application and finishing of Gypsum Linings, AS/ NZS 2589:2007 stipulates a Level 4 finish to comply with the requirements of the standard, with certain exceptions, therefore 3 separate applications of setting compounds, sanded as necessary, are required to comply. Reference should be made to the lining board manufacturer for further details.

Arch Beads

STEP ONE

Position the bead so that the short perforated leg is to the face of the wall and the longer perforated leg is to the arch soffit.

STEP TWO

Fix one end of the arch bead 150mm below the springing line.

STEP THREE

Carefully bend the bead to the profile of the arch, fixing it at 300 mm centres along its length, allowing the bead to finish 150mm below the springing line.

STEP FOUR

Fix the Rondo external corner bead to the vertical edges of the wall to “bond” into the arch bead.

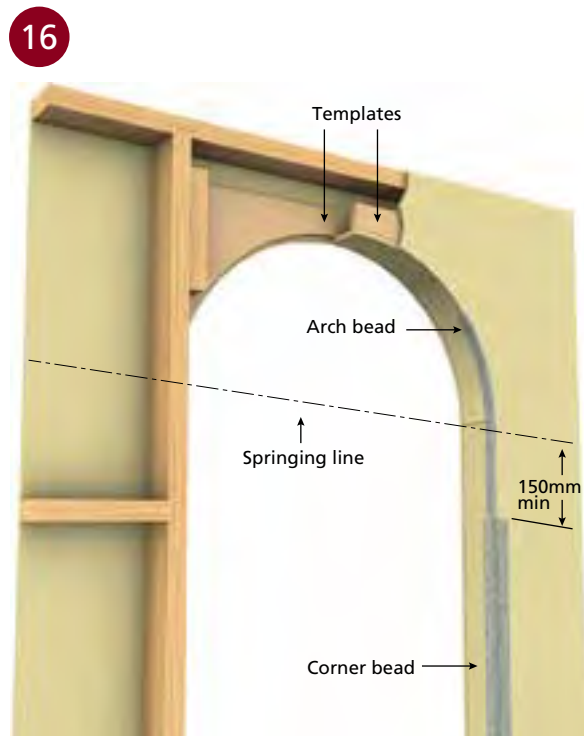

■ ARCH BEAD INSTALLATION

P35 Control Joint

STEP ONE

Ensure there is a complete break in the framing behind the Control Joint.

STEP TWO

Allow a 20mm gap between the plasterboard sheets.

STEP THREE

Locate the Rondo P35 Control Joint centrally in the gap. Fasten the flanges to the building board sheets at a maximum of 150mm centres.

STEP FOUR

Set over the bead as for normal joint application using the centre channel nibs as screeding guides.

STEP FIVE

Finish the joint in the normal manner. When the joint is dry, remove the protective filament tape.

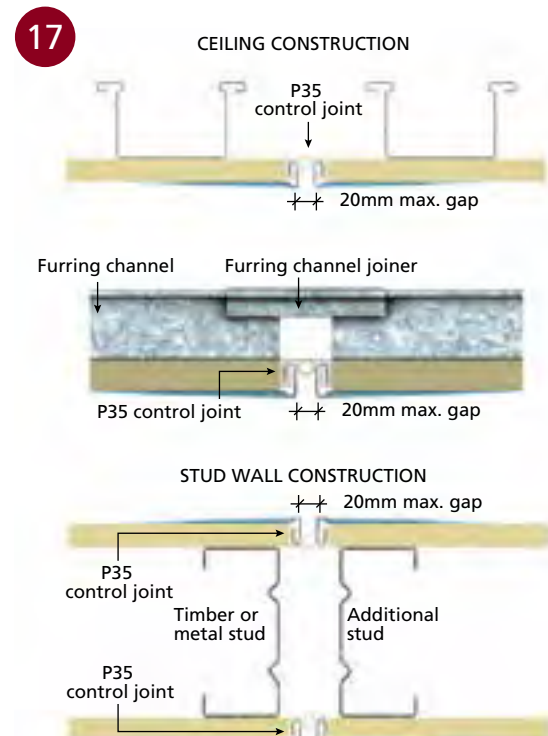

■ P35 INSTALLATION