

RONDO
XPRESS[®]



DRYWALL
GRID SYSTEM

RONDO[®]

STANDARDS AND BUILDING CODES

Rondo Building Services uses the following Standards in its manufacturing, testing and marketing policies for compliance with the respective Building Codes of Australia and New Zealand:

- AS/NZS 1170 Structural Design Actions
- AS 1170.4 Earthquake Loads (Australia)
- AS 1397 Continuous hot-dip metallic coated steel sheet and strip – Coatings of zinc and zinc alloyed with aluminium and magnesium
- AS/NZS 2785 Suspended Ceilings, Design and Installation
- AS/NZS 4600 Cold Formed Steel Structures Code

- NZS 1170.5 Earthquake Loads (New Zealand)
- NZS 4219 Specification for Seismic Resistance of Engineered Systems in Buildings

- NZBC–
B1/VM1 NZ Building Code Verification Method B1/VM1 Clause 2
- NZBC – B2 Durability
Rondo XPRESS® Drywall Grid System will have a minimum serviceable life of 15 years when installed in a dry, noncorrosive, interior installation

RONDO XPRESS® DRYWALL GRID SYSTEM

INTRODUCTION

The Rondo XPRESS® Drywall Grid System is light-weight and simple to install.

The Main Tee and Cross Tee connection uses the same patented QRC clip technology that is known and preferred by installers and found in the Rondo DONN® Exposed Grid System.

With an ability to be used in acoustic, seismic and fire-rated applications, the Rondo XPRESS® Drywall Grid System offers design flexibility for flush ceilings, bulkheads and boxed soffits.

SUITABLE FOR

- Concealed ceiling systems
- Plasterboard, fibrous plaster and fibre cement linings
- Direct fix or fully suspended applications
- Seamless transitions from a concealed to exposed grid ceilings
- Bulkheads and boxed soffits
- Corridors, without the use of suspension hangers
- Fire-rated applications
- Seismic requirements
- Acoustic requirements

SPECIAL FEATURES

- Surface Finish: Z275 galvanised
- Easy integration with Rondo Exposed Grid Ceiling Systems
- Accepts conventional light fixtures, air conditioning services and access panels
- Main Tee and Cross Tee clips have a secure connection and are easy to remove and relocate
- QRC Clip Technology

IMPORTANT NOTES:

Rondo recommends its products and systems are installed by a qualified tradesperson and according to the relevant codes and standards. Rondo recommends that before acting on any advice or opinion in this manual, you should seek professional advice in light of your own architectural and building requirements.

FIRE RATING: The Rondo XPRESS® Drywall Grid Ceiling System has been tested and certified for varying Fire Resistant Ratings (FRR/FRL) but ONLY with appropriate board manufacturer Fire Rated Gypsum Boards.

Reference should be made to the board manufacturer for relevant test data information.

SEISMIC DESIGN: Reference is made in this manual to seismic specific components and design criteria of the Rondo XPRESS® System. For seismic specific project design specifications and full advice please contact Rondo Building Services direct.

The Rondo XPRESS® Drywall Grid is a non-trafficable ceiling system.

CONTENTS:

COMPONENTS	2
PRODUCT DATA SPECIFICATIONS	4
FLAT PLASTERBOARD CEILINGS	6
TYPICAL FRAMING DETAILS	7
TYPICAL APPLICATION DETAILS	8
EXPANSION & CONTROL JOINTS	9
LOAD TABLES & GRID CONFIGURATIONS	10
APPLICATION OF GYPSUM PANELS	12
TRANSITION TO THE RONDO DONN® EXPOSED GRID SYSTEM	13
TYPICAL APPLICATION DETAILS	14
RONDO XPRESS® DRYWALL TRANSITION CLIP	16
CORRIDOR CEILINGS	18
LOAD TABLES	20
BULKHEADS & BOXED SOFFITS	
TYPICAL APPLICATION DETAILS	22
LIGHTING & ACCESS PANELS	24
TYPICAL APPLICATION: LIGHTING FIXTURES	25
OFF-MODULE GRID	26
RONDO X19 STRONGBACK CLIP	27
STRONGBACK CLIP DETAILS	28
RONDO XPRESS® COMPLEMENTARY ACCESSORIES	29
WIND LOADING TABLES	30

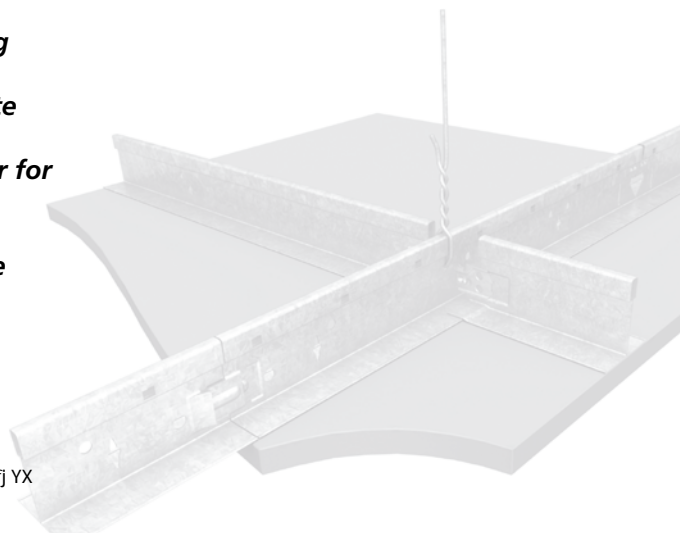

RONDO XPRESS® SYSTEM COMPONENTS

MAIN TEES

XD1	38mm (h) x 38mm (face) Main Tee
XD1H	38mm (h) x 38mm (face) Heavy Gauge Main Tee
XD3	38mm (h) x 24mm (face) Main Tee
XD3H	38mm (h) x 24mm (face) Heavy Gauge Main Tee
XDWS	38mm (h) x 24mm (face) Wall to Wall Main Tee
XDWH	38mm (h) x 38mm (face) Heavy Gauge Wall to Wall Main Tee

CROSS TEES

XD2	38mm (h) x 38mm (face) Cross Tee
XD4	38mm (h) x 24mm (face) Cross Tee

WALL TRIMS

XD5	40mm (h) x 40mm (w) Wall Angle
553	35mm (h) x 35mm (w) Wall Angle
XD6	40mm (h) x 38mm (w) x 19mm (w) Perimeter Channel
WASL	27mm (h) x 10mm (w) x 10mm (h) x 19mm (w) Shadowline Long Leg Wall Angle
SA12	40mm (h) x 40mm (w) Wall Angle

CLIPS

XDSC	Splice Clip – 180°
XD10	Transition Clip – 90°
XD11	Acoustical Transition Clip – Rondo XPRESS® to Rondo DONN®
XD12	100mm Fascia Drywall Clip
XD13	150mm Fascia Drywall Clip
XD14	200mm Fascia Drywall Clip
XD16	Main Tee Separation Joint Clip
XD17	Seismic Clip
XD19	Strongback Clip
XD36	3-Way Off-Module Connector

MAIN TEES



XD1/XD1H



XD3/XD3H



XDWS



XDWH

CROSS TEES



XD2



XD4

WALL TRIMS



XD5



553



XD6



WASL



SA12

CLIPS



XDSC



XD10



XD11



XD12/XD13/XD14



XD16



XD17



XD19



XD36

SUSPENSION CLIPS, BRACKETS, RODS & WIRE

DXCL	Adjustable Suspension Clip - 121 Rod to DONN® Main Tee
DXDF	Direct Fix Strap
120	Ø2.5mm Soft Gal Wire
121	Ø5mm Soft Gal Suspension Rod
122	Ø5.3mm Soft Galvanised Suspension Rod – M6 Thread at one end
247	60mm (h) x 25mm (w) x 21mm (l) Bracket – 121 Rod to Masonry/Concrete
274	80mm (h) x 25mm (w) Bracket – 121 Rod to Timber/Steel
534	110mm (h) x 38mm (w) Adjustable Suspension Bracket – 121 Rod to Timber/Steel
547	78mm (h) x 38mm (w) Adjustable Suspension Bracket – 121 Rod to Masonry/Concrete
826	M6 Nuts to suit 122

DIRECT FIX BRACKETS

XD26	Direct Fix Angle Bracket – 180 x 40mm
XD27	Direct Fix Angle Bracket – 120 x 40mm
XD28	Direct Fix Clip – 180mm Extension Strip
XD29	Direct Fix Clip – 180 x 50mm

DELIVERY, STORAGE & HANDLING

- All materials shall be delivered in their original, unopened packages and stored for as short a time as possible, in an enclosed shelter providing protection from exposure to the elements and damage by/to other trades. Damaged, deteriorated or obviously faulty material is not to be installed and shall be removed from the premises.
- Materials should be handled in such a manner as to prevent racking distortion or physical damage.

SUSPENSION CLIPS, BRACKETS, RODS & WIRE



DIRECT FIX BRACKETS

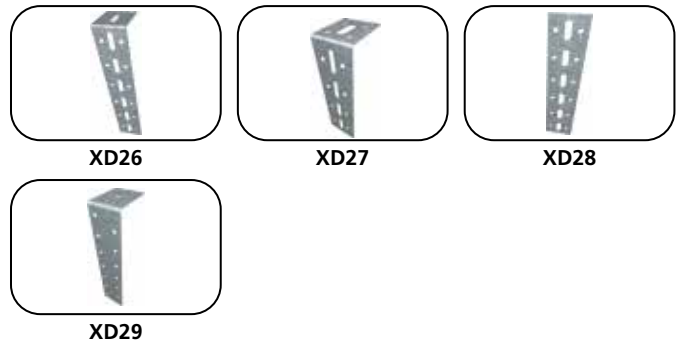

PRODUCT DATA SPECIFICATIONS

MAIN TEES

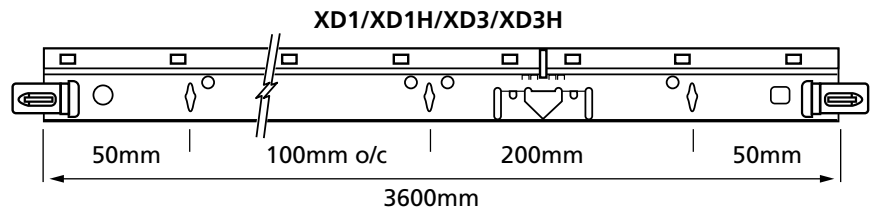

	PART NO	LENGTH (mm)	HEIGHT (mm)	WIDTH (mm)	GAUGE (bmt)	FIRE RATED
	XD1	3600	38	38	0.38	YES
	XD1H	3600	38	38	0.50	YES
	XD3	3600	38	24	0.38	YES
	XD3H	3600	38	24	0.50	YES

CROSS TEES

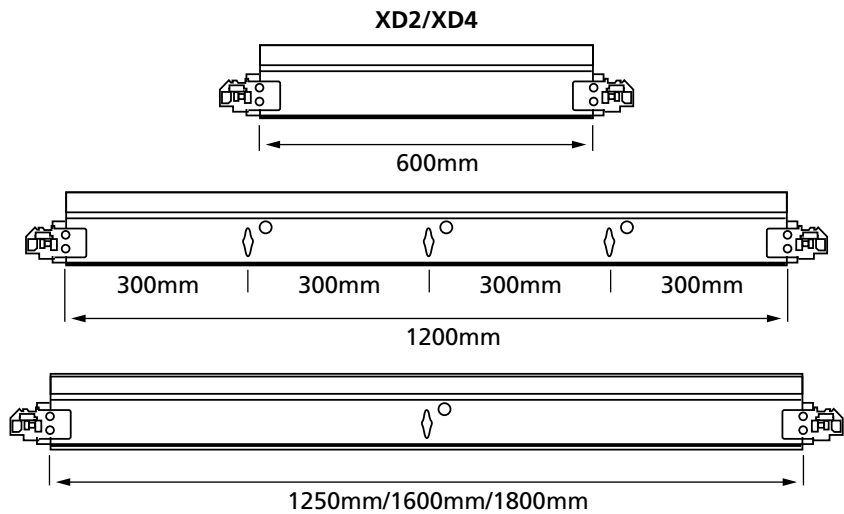

	PART NO	LENGTH (mm)	HEIGHT (mm)	WIDTH (mm)	GAUGE (bmt)	FIRE RATED
	XD2	600	38	38	0.38	YES
	XD2	1200	38	38	0.38	YES
	XD2	1250	38	38	0.38	YES
	XD2	1500	38	38	0.38	YES
	XD2	1600	38	38	0.38	YES
	XD2	1800	38	38	0.38	YES
	XD4	600	38	24	0.38	YES
	XD4	1200	38	24	0.38	YES

WALL TRACK & WALL ANGLES



XD5

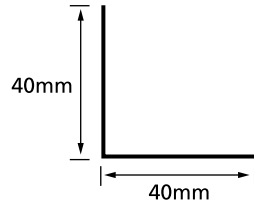

PART NO	LENGTH (mm)	HEIGHT (mm)	WIDTH (mm)	GAUGE (bmt)
XD5	3600	40	40	0.55



XD6

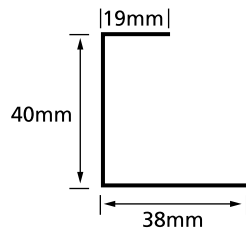

PART NO	LENGTH (mm)	HEIGHT (mm)	WIDTH (mm)	GAUGE (bmt)
XD6	3600	40	38	0.55

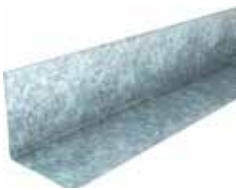

553

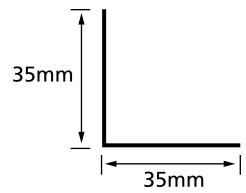

PART NO	LENGTH (mm)	HEIGHT (mm)	WIDTH (mm)	GAUGE (bmt)
553	3600	35	35	0.70



WASL

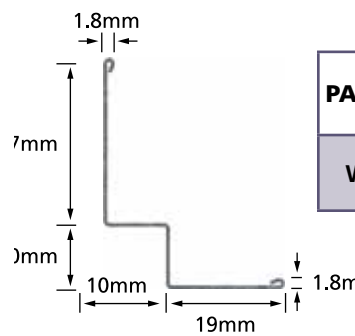

PART NO	LENGTH (mm)	HEIGHT (mm)	WIDTH (mm)	GAUGE (bmt)
WASL	3600	(See Detail)		0.50

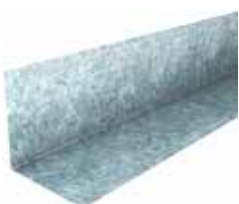

SA12

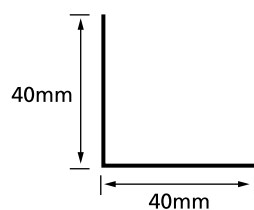

PART NO	LENGTH (mm)	HEIGHT (mm)	WIDTH (mm)	GAUGE (bmt)
SA12	3600	40	40	1.15

FLAT PLASTERBOARD CEILINGS

The Rondo XPRESS® Drywall Grid Ceiling System is fast and simple to install and results in a flush plasterboard finish.

- Fast and simple to install
- Two fire-rated Main Tees and Cross Tees (24mm or 38mm wide face)
- Fast, locked in connections
- Easy transitions to exposed grid, bulkheads, soffits, flat and curved fascias
- Quick release tab on Cross Tees
- Main Tees have indexed Cross Tee hole locations for faster and more accurate installations
- Suitable for both lay-in and framed lights

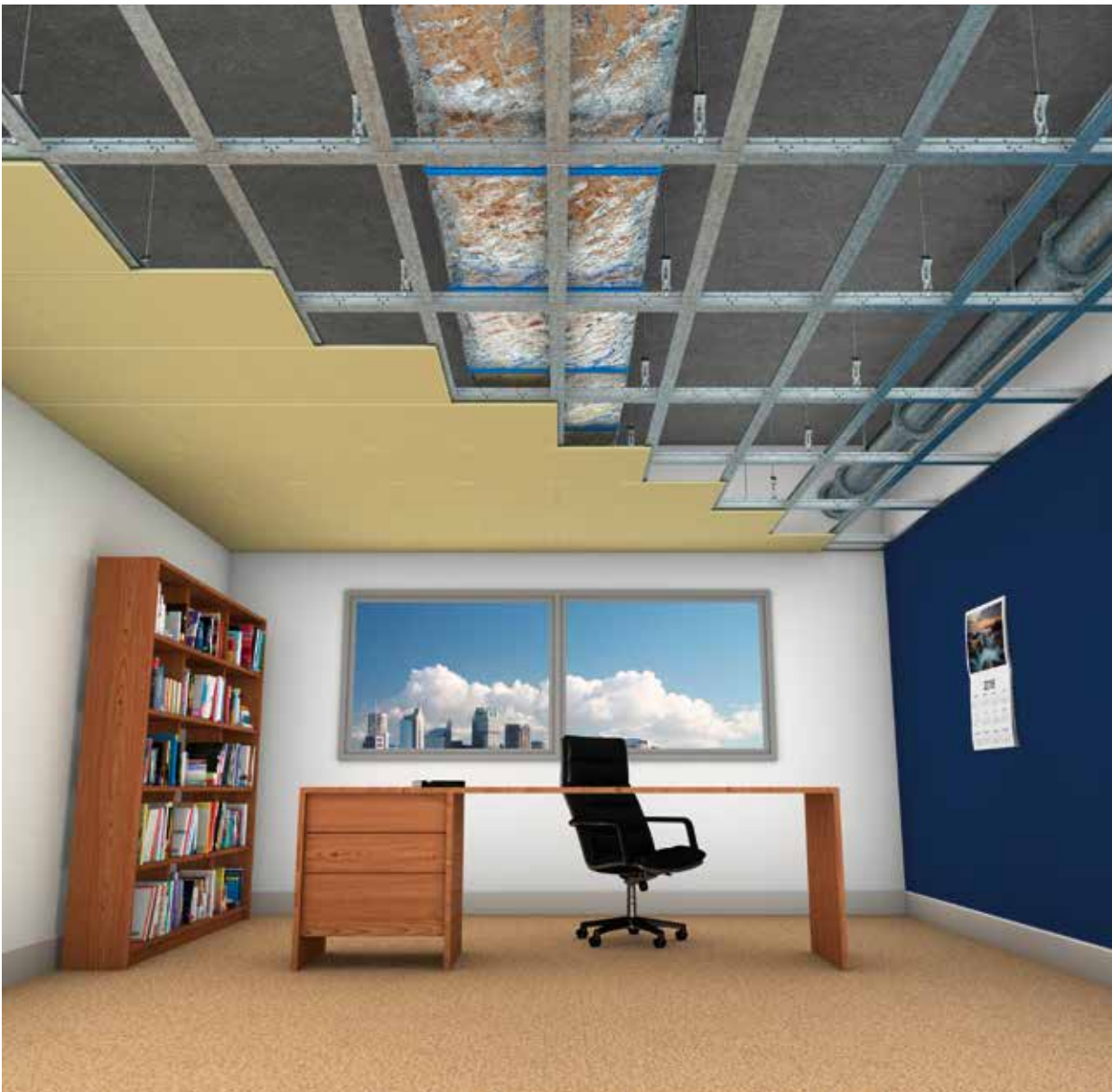

Typical Framing Details

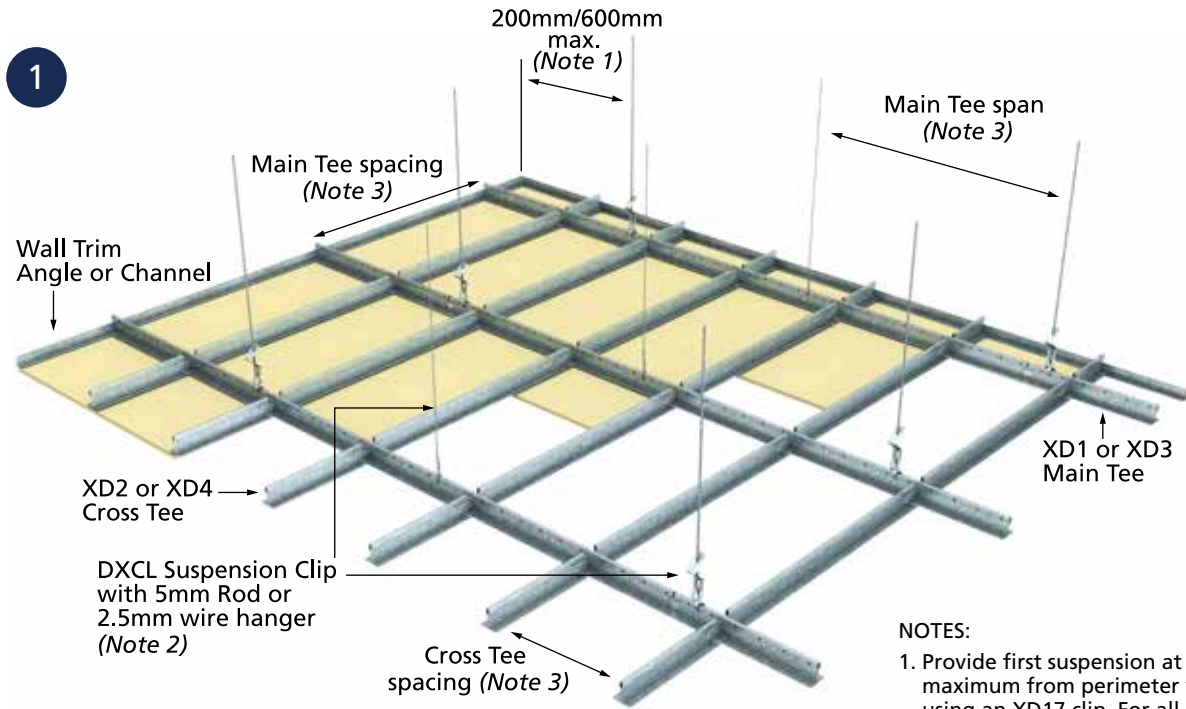

NOTES:

1. Provide first suspension at 600mm maximum from perimeter wall when using an XD17 clip. For all other situations first suspension point is 200mm maximum.
2. Suspension shown is indicative only. Rondo does not recommend mixing of suspension systems within the ceiling grid. Refer to design tables for grid suspension capacity.
3. Typical details. For Main and Cross Tee spans refer to tables.

■ TYPICAL RONDO XPRESS® DRYWALL FLAT CEILING

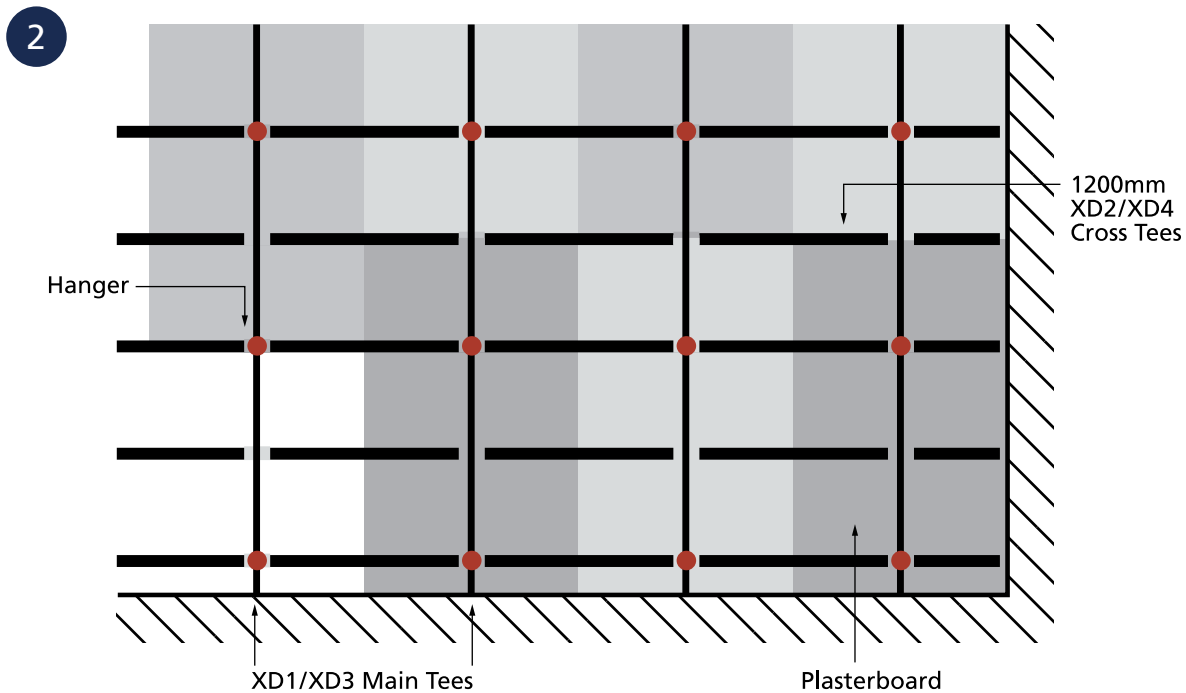

NOTE: When butt-joining on Cross Tees, it is recommended to stagger adjacent sheets for a better joint finish.

■ PLAN VIEW OF TYPICAL RONDO XPRESS® DRYWALL FLAT CEILING

FLAT PLASTERBOARD CEILINGS (continued)

Typical Application Details

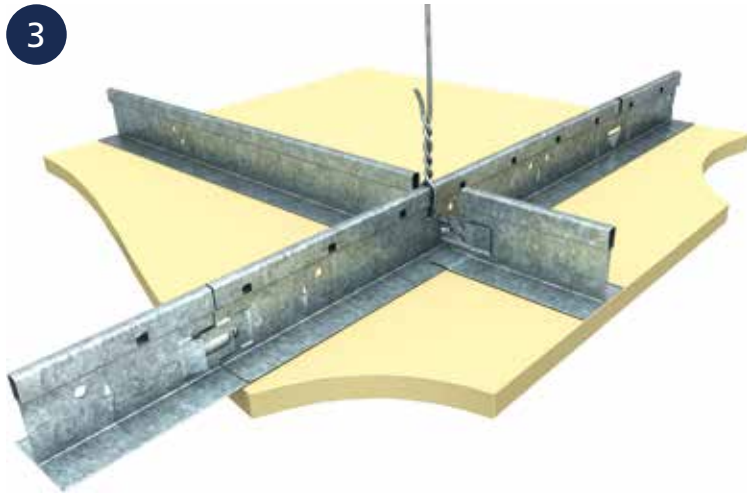

3 MAIN TEE & CROSS TEE INTERSECTION

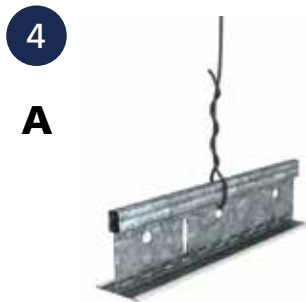

4 A

Rondo 120 soft galvanised wire secured with three tight 360° turns



B

Suspension Clip Part No DXCL

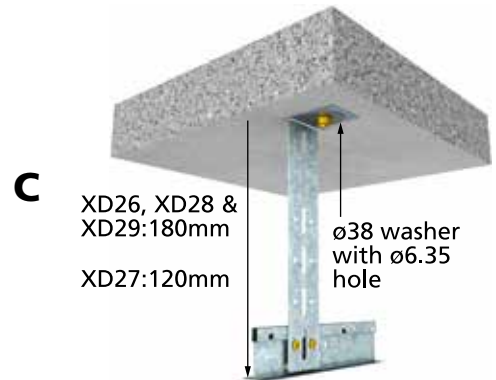

C

XD26, XD28 & XD29: 180mm
XD27: 120mm

ø38 washer with ø6.35 hole

Direct Fix Suspension Bracket

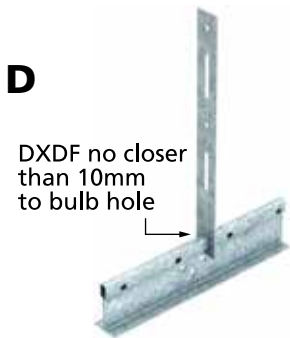

D

DXDF no closer than 10mm to bulb hole

Direct Fix Strap Part No DXDF



E

2/#10 wafer head screws, installed from Tee Bar side

XD5/553 secured to tee web

TYPICAL SUSPENSION HANGERS



5 PERIMETER DETAIL: XD6

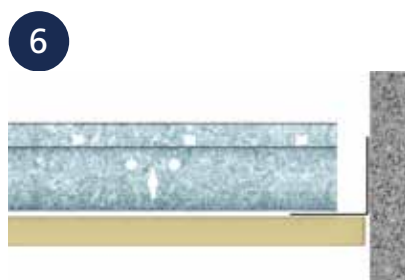

6 PERIMETER DETAIL: XD5

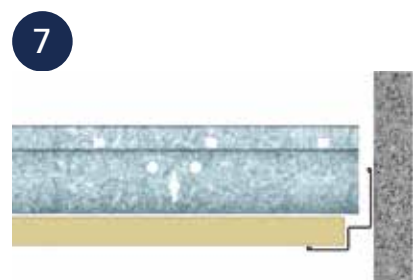

7 PERIMETER DETAIL: WASL

NOTE: Trim to be fixed to wall, max 600mm centres. Fixing to be relevant to wall strata (e.g. plug & screw or suitable fixings). Seismic requirements may take precedence of type and quantity of fixings.

Expansion & Control Joints

EXPANSION JOINTS

Expansion joints allow for building movement, expansion, and contraction in large ceiling areas. This is achieved by a separation in the suspension system, where Main Tees are installed parallel to each other and are able to move independently.

8

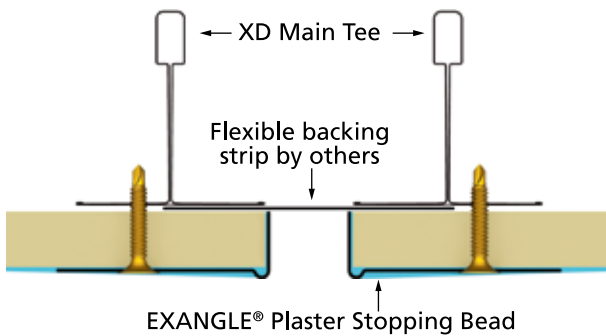

■ EXPANSION JOINT – NON FIRE-RATED

CONTROL JOINTS

Control joints are used to control stress caused by expansion and contraction across large ceiling expanses in drywall plasterboard systems.

Maximum distances are defined by the plasterboard manufacturers, but generally recommended not to exceed 12m in any direction with perimeter relief.

9

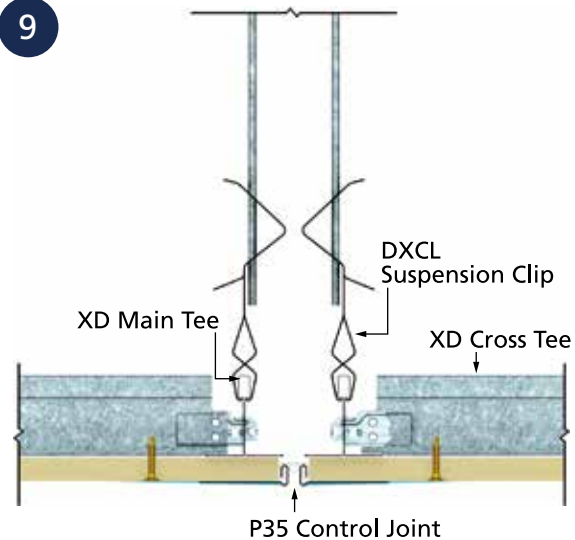

■ USING RONDO P35 CONTROL JOINT – NON FIRE-RATED

NOTES

Location of control and expansion joints are the responsibility of the design professional. Gypsum panel surfaces should be isolated with control joints, caulk, or other means where:

1. Ceiling or soffit abuts a structural element, column, partition, or other vertical penetration.
2. Construction changes within a plane of the ceiling.
3. Ceiling dimensions exceed 12-15m in either direction with perimeter relief or 9-12m without relief.
4. Soffit exceeds 9m in either direction.
5. Wings of "T", "L" and "U" shaped ceilings areas are joined.
6. For fire-rated ceilings, Control Joints shall not occur within 300mm of the fire expansion notch. Do not separate suspension – use continuous single main tees.

Control and expansion joints shall be adequately sealed behind the joints where sound and/or fire ratings are prime considerations. Refer to the plasterboard manufacturers recommendations for fire-rated control joints.

LOAD TABLES & GRID CONFIGURATIONS

Maximum Spans: Ceilings

A	Main Tee	Cross Tee	Cross Tee Length	Spacing of Cross Tee	Main Tee Span		
					900	1050	1200
					Allowable Load (kg/m ²)		
	XD1	XD2	1200	600	34.00	32.40	18.00
				400	46.10	32.40	18.00
		XD4	1200	600	29.50	29.50	18.00
				400	46.10	32.40	18.00
	XD1H	XD2	1200	600	34.00	34.00	28.80
				400	53.40	42.80	28.80
		XD4	1200	600	29.50	29.50	28.80
				400	46.70	42.80	28.80
	XD3	XD2	1200	600	34.00	28.00	15.40
				400	42.90	28.00	15.40
		XD4	1200	600	29.50	28.00	15.40
				400	42.90	28.00	15.40
XD3H	XD2	1200	600	34.00	34.00	27.00	
			400	53.40	40.70	27.00	
	XD4	1200	600	29.50	29.50	27.00	
			400	46.70	40.70	27.00	

B	Main Tee	Cross Tee	Cross Tee Length	Spacing of Cross Tee	900	1050	1200
					Allowable Load (kg/m ²)		
						XD1	XD2
400	44.00	30.90	17.10				
XD4	1250	600	25.00	25.00			17.10
		400	40.00	30.90			17.10
XD1H	XD2	1250	600	29.20		29.20	27.40
			400	46.20		40.90	27.40
	XD4	1250	600	25.00		25.00	25.00
			400	40.00		40.00	27.40
XD3	XD2	1250	600	29.20		26.70	14.60
			400	41.00		26.70	14.60
	XD4	1250	600	25.00		25.00	14.60
			400	40.00		26.70	14.60
XD3H	XD2	1250	600	29.20	29.20	25.70	
			400	46.20	38.90	25.70	
	XD4	1250	600	25.00	25.00	25.00	
			400	40.00	38.90	25.70	

C	Main Tee	Cross Tee	Cross Tee Length	Spacing of Cross Tee	900	1050	1200
					Allowable Load (kg/m ²)		
						XD1	XD2
400	21.60	21.60	13.40				
XD4	1500	600	10.40	10.40			10.40
		400	18.10	18.10			13.80
XD1H	XD2	1500	600	12.80		12.80	12.80
			400	21.60		21.60	21.60
	XD4	1500	600	10.40		10.40	10.40
			400	18.10		18.10	18.10
XD3	XD2	1500	600	12.80		12.80	11.40
			400	21.60		21.40	11.40
	XD4	1500	600	10.40		10.40	10.40
			400	18.10		18.10	11.40
XD3H	XD2	1500	600	12.80	12.80	12.80	
			400	21.60	21.60	20.60	
	XD4	1500	600	10.40	10.40	10.40	
			400	18.10	18.10	18.10	

D

Main Tee	Cross Tee	Cross Tee Length	Spacing of Cross Tee	Main Tee Span		
				900	1050	1200
				Allowable Load (kg/m ²)		
XD1	XD2	1600	600	9.00	9.00	9.00
			400	16.00	16.00	12.30
	XD4	1600	600	7.20	7.20	7.20
			400	13.20	13.20	12.30
XD1H	XD2	1600	600	9.00	9.00	9.00
			400	16.00	16.00	16.00
	XD4	1600	600	7.20	7.20	7.20
			400	13.20	13.20	13.20
XD3	XD2	1600	600	9.00	9.00	9.00
			400	16.00	16.00	10.30
	XD4	1600	600	7.20	7.20	7.20
			400	13.20	13.20	10.30
XD3H	XD2	1600	600	8.50	8.50	8.50
			400	16.00	16.00	16.00
	XD4	1600	600	7.20	7.20	7.20
			400	13.20	13.20	13.20

E

Main Tee	Cross Tee	Cross Tee Length	Spacing of Cross Tee	900	1050	1200
				Allowable Load (kg/m ²)		
				XD1	XD2	1800
300	13.20	13.20	10.40			
XD4	1800	400	6.90		6.90	6.90
		300	10.90		10.90	10.40
XD1H	XD2	1800	400	8.70	8.70	8.70
			300	13.20	13.20	13.20
	XD4	1800	400	6.90	6.90	6.90
			300	10.90	10.90	10.90
XD3	XD2	1800	400	8.70	8.70	8.70
			300	13.20	13.20	8.70
	XD4	1800	400	6.90	6.90	6.90
			300	10.90	10.90	8.70
XD3H	XD2	1800	400	8.70	8.70	8.70
			300	13.20	13.20	13.20
	XD4	1800	400	6.90	6.90	6.90
			300	10.90	10.90	10.90

NOTES:

1. The above tables provide the allowable lining weights that can be affixed to the ceiling grid. Accordingly, the above weights can be compared directly to manufacturers' published weight data as a means of checking the adequacy of the ceiling grid.
2. All load combinations, as per AS/NZS2785, considered in the preparation of the above tables. ULS: 1.4G + 1.7U SLS: G + U
3. Connections have been checked against the details on Page 8, and throughout this manual. Alternative suspension arrangements shall be referred to Rondo.
4. Deflection limited to L/360 unless noted otherwise.
5. Lining contribution has been ignored in the analysis of serviceability.
6. The above design tables assume the ceiling plenum is vented, such that there is no possibility of a differential pressure across the ceiling grid. Where the ceiling is forming a pressure seal to the plenum, reference should be made to AS/NZS1170.2 for internal pressures, and the ceiling checked using the Wind Loading Tables on Page 30.
7. Seismic designs for this ceiling grid will need to be referred to Rondo.
8. Cross Tee member sizes 1250mm and 1800mm are made to order.

APPLICATION OF GYPSUM PANELS

The Rondo XPRESS® Drywall Grid System is engineered to provide the ultimate in design flexibility and will accept a variety of gypsum panels for flat ceiling applications. Alternative lining materials may be used provided they and other utility fixtures combined weight does not exceed the maximum allowable ceiling load as detailed on page 10.

COMMON GYPSUM BOARD AND RONDO XPRESS® DRYWALL GRID SYSTEM COMBINATIONS

BOARD THICKNESS	DEFLECTION	MINIMUM MAIN TEE TYPE	MAXIMUM MAIN TEE ON CENTRE SPACING	MAXIMUM CROSS TEE ON CENTRE SPACING ³	MAXIMUM SUSPENSION SPACING
10mm Single Layer	L/450	XD3-3600	1200mm	400mm	1400mm
10mm Double Layer	L/450 or L/600	XD3-3600	1200mm	400mm	1000mm
13mm Single Layer	L/450 or L/600	XD3-3600	1200mm	600mm	1200mm
13mm Double Layer	L/450	XD3H-3600	1200mm	600mm	1200mm
16mm Single Layer	L/450 or L/600	XD3-3600	1200mm	600mm	1000mm
16mm Double Layer	L/450	XD3H-3600	1200mm	600mm	1000mm
13mm plus 16mm Double Layer	L/450	XD3H-3600	1200mm	600mm	1200mm
13mm plus 16mm Double Layer	L/600	XD3H-3600	1200mm	400mm	1200mm

- The above grid configurations have been checked using the following lining weights:
 - grid system weight, as calculated
 - for 10 and 13mm single board systems, regular plasterboard weights
 - for 13mm and 16mm double layers and combinations, fire grade plasterboard weights
- The above does not consider fire rating, which is to be checked with your board manufacturer.
- Load combinations have been checked in accordance with AS/NZS2785, as applicable.
- Cross Tee is XD4 in all grid configurations above.
- Additional loading, over and above the lining weight, has not been considered. Where this occurs, refer to Rondo for a specific design.

TRANSITION TO THE RONDO DONN® EXPOSED GRID CEILING SYSTEM (ACOUSTICAL SUSPENSION SYSTEM)

The Rondo XPRESS® Drywall Grid Ceiling System is compatible with the Rondo DONN® Exposed Grid Ceiling System, making it easy to transition between concealed and exposed ceilings.

Both flush and offset transitions are possible, and additional Cross Tees are necessary at plasterboard edges to provide adequate support (see plan view below).

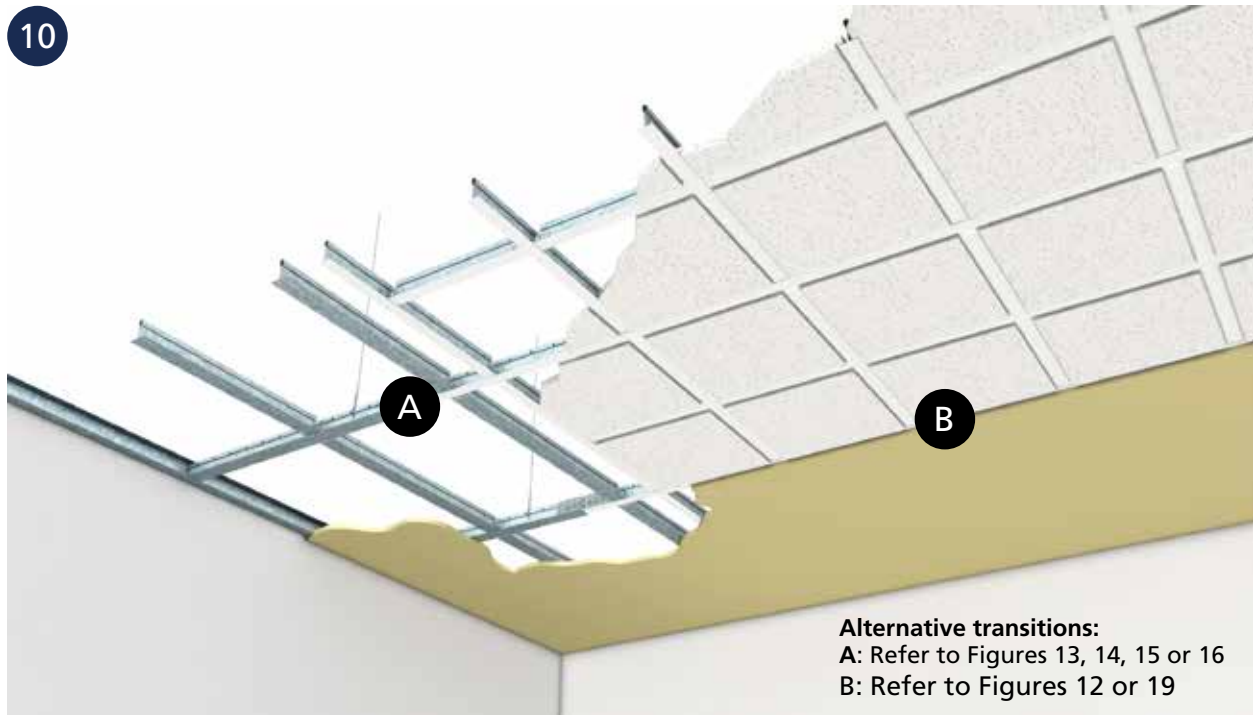

Alternative transitions:
 A: Refer to Figures 13, 14, 15 or 16
 B: Refer to Figures 12 or 19

■ TYPICAL RONDO XPRESS® DRYWALL TRANSITION

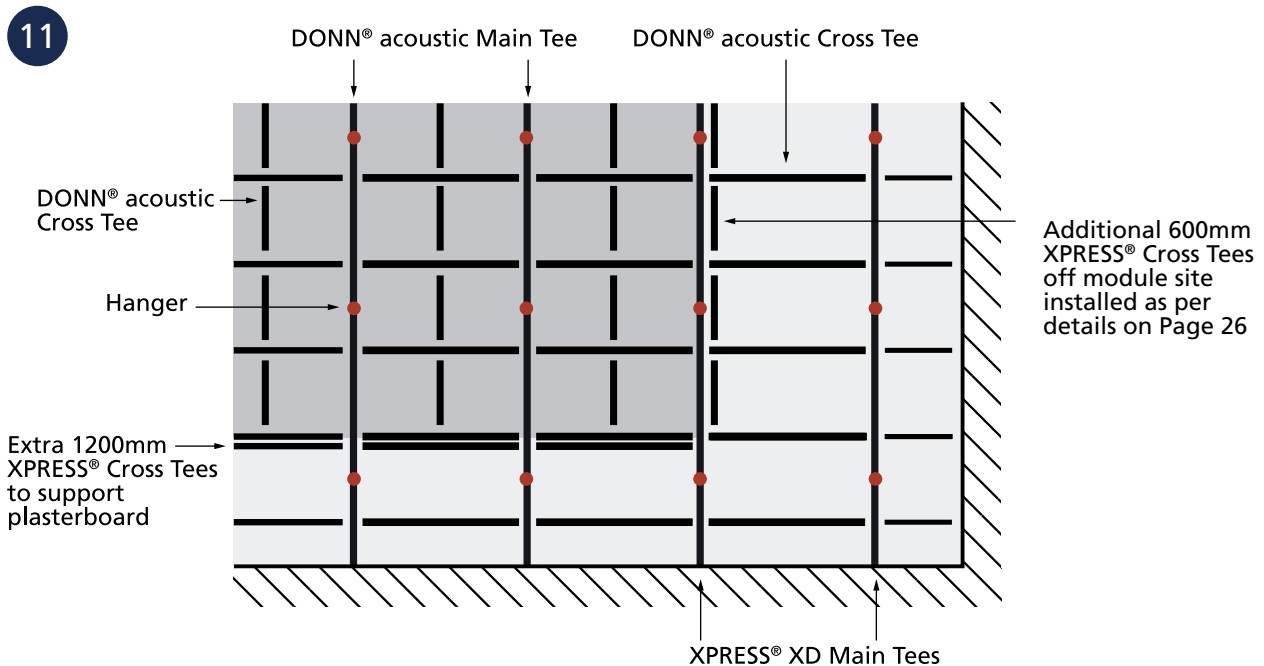

■ TYPICAL PLAN VIEW OF RONDO XPRESS® DRYWALL TRANSITION

TRANSITION TO THE RONDO DONN® SYSTEM (continued)

Typical Application Details

12

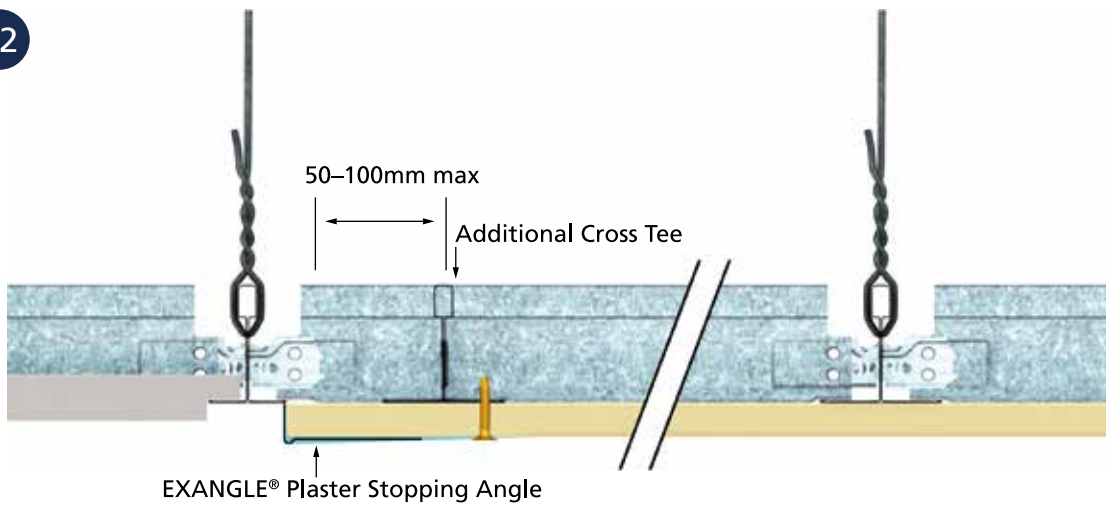

■ RONDO XPRESS® DRYWALL TO RONDO DONN® EXPOSED GRID TRANSITION

13

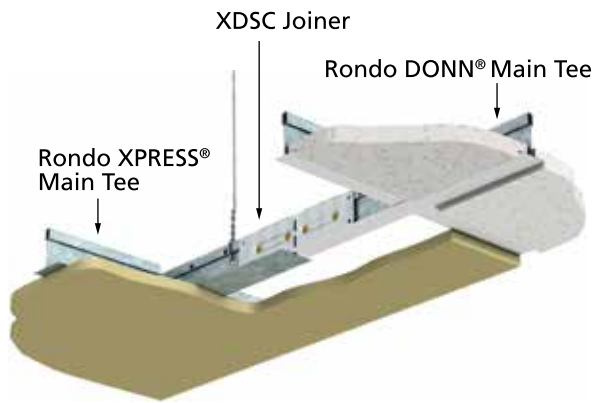

■ DRYWALL TO EXPOSED GRID TRANSITION:
FIELD CUT CONNECTION

14

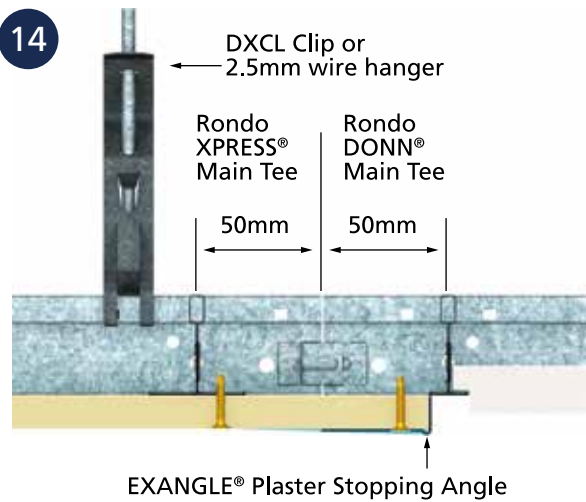

■ DRYWALL TO EXPOSED GRID TRANSITION:
FACTORY END CONNECTION

15

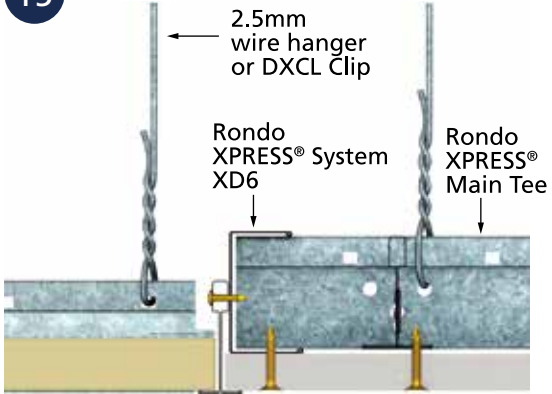

■ FLUSH TRANSITION

16

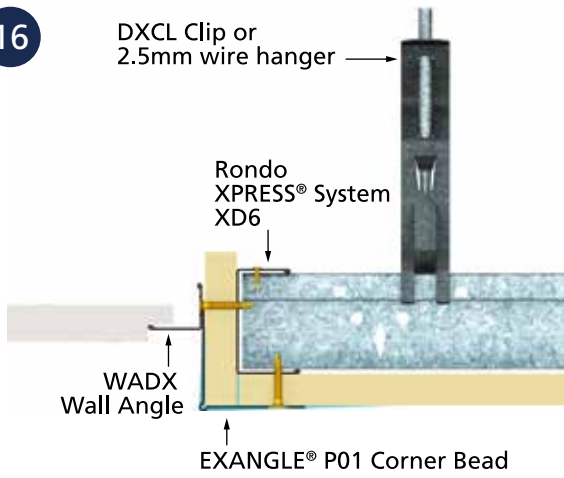

■ STANDARD OFFSET TRANSITION

RONDO XPRESS® DRYWALL TRANSITION CLIP

The Transition Clip provides seamless transitions between concealed and exposed grid ceilings, offering designers greater flexibility.

Where a flush transition is desired, the Rondo XD11 Clip can be used to accept Rondo XPRESS® Grid as shown below.

NOTE:

The XD11 clip is not suitable to maintain grid continuity in medium to high seismic load applications. Refer to Rondo for these situations, if the XD11 clip is proposed.

17



■ XD11 ACOUSTICAL TRANSITION CLIP

18

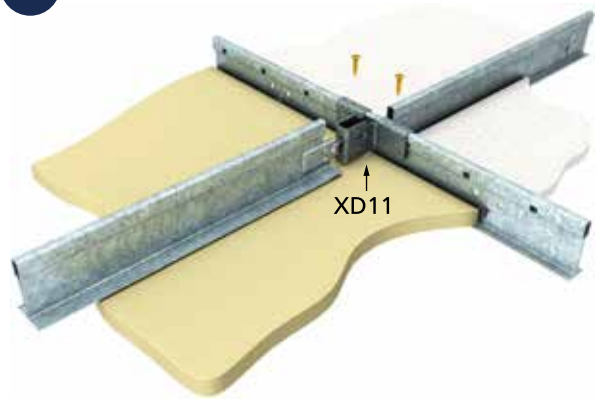

■ XD11 ACOUSTICAL TRANSITION CLIP APPLICATION

19

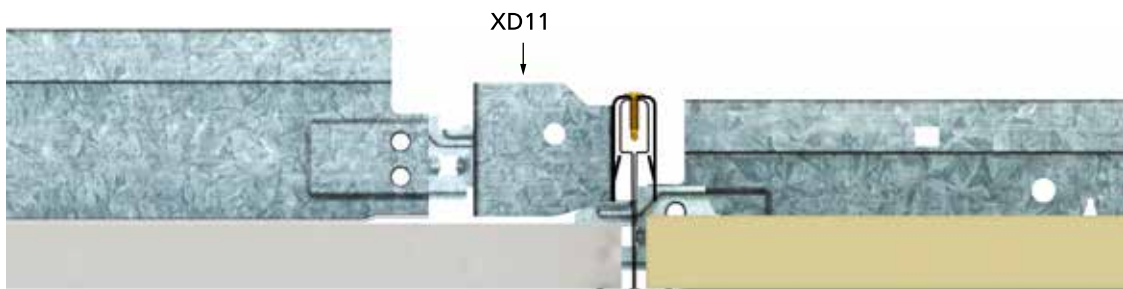

■ RONDO XPRESS® DRYWALL TRANSITION CLIP INTERSECTION DETAILS

For Main Tee direction, keep the Rondo DONN® Exposed Grid Main Tees and the Rondo XPRESS® Drywall Main Tees in line.
 Three options are shown below.

20

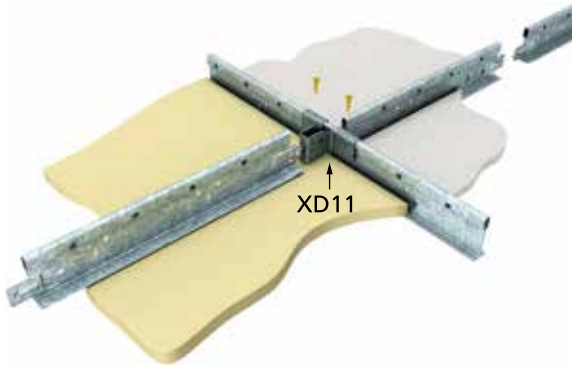

■ OPTION 1: XD11 TRANSITION CLIP

21

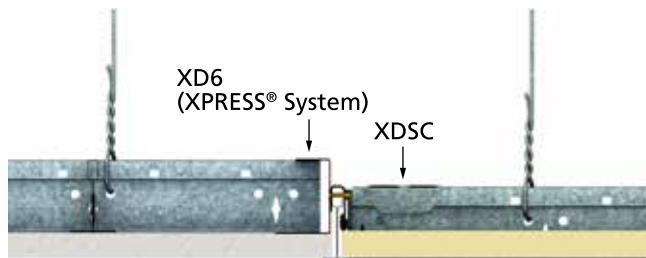
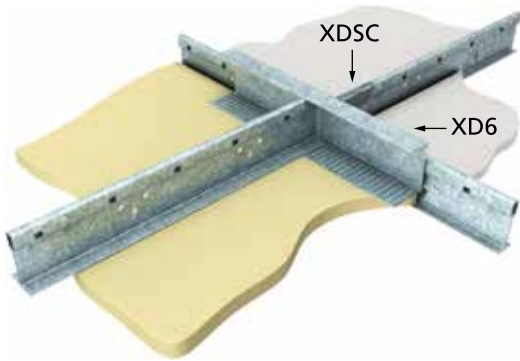

■ OPTION 2: XDSC SPLICE CLIP & XD6 WALL CHANNEL

22

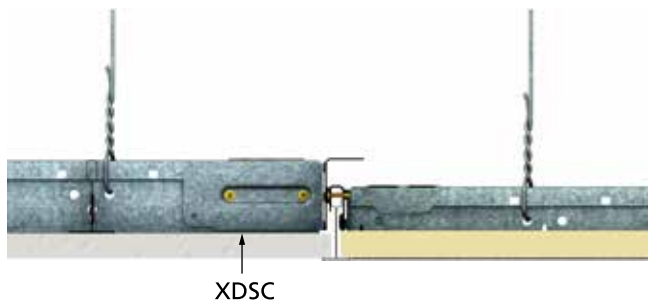
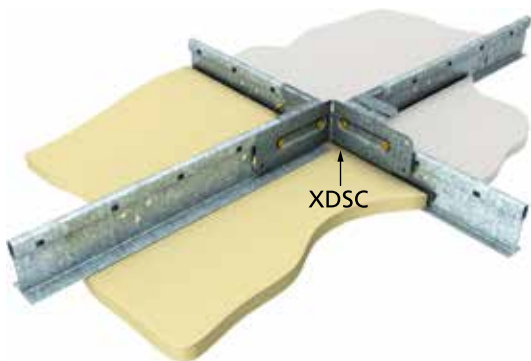

■ OPTION 3: XDSC SPLICE CLIP

CORRIDOR CEILINGS

In corridors a situation often occurs where it is impossible to install a suspended ceiling due to the services; including air conditioning ducts, electrical and data cabling, fire sprinkler pipework.

The Rondo XPRESS® Drywall Grid Ceiling System can be used without suspension hangers making it an ideal solution for corridors.



■ TYPICAL APPLICATION RONDRO XPRESS® DRYWALL CORRIDOR

23

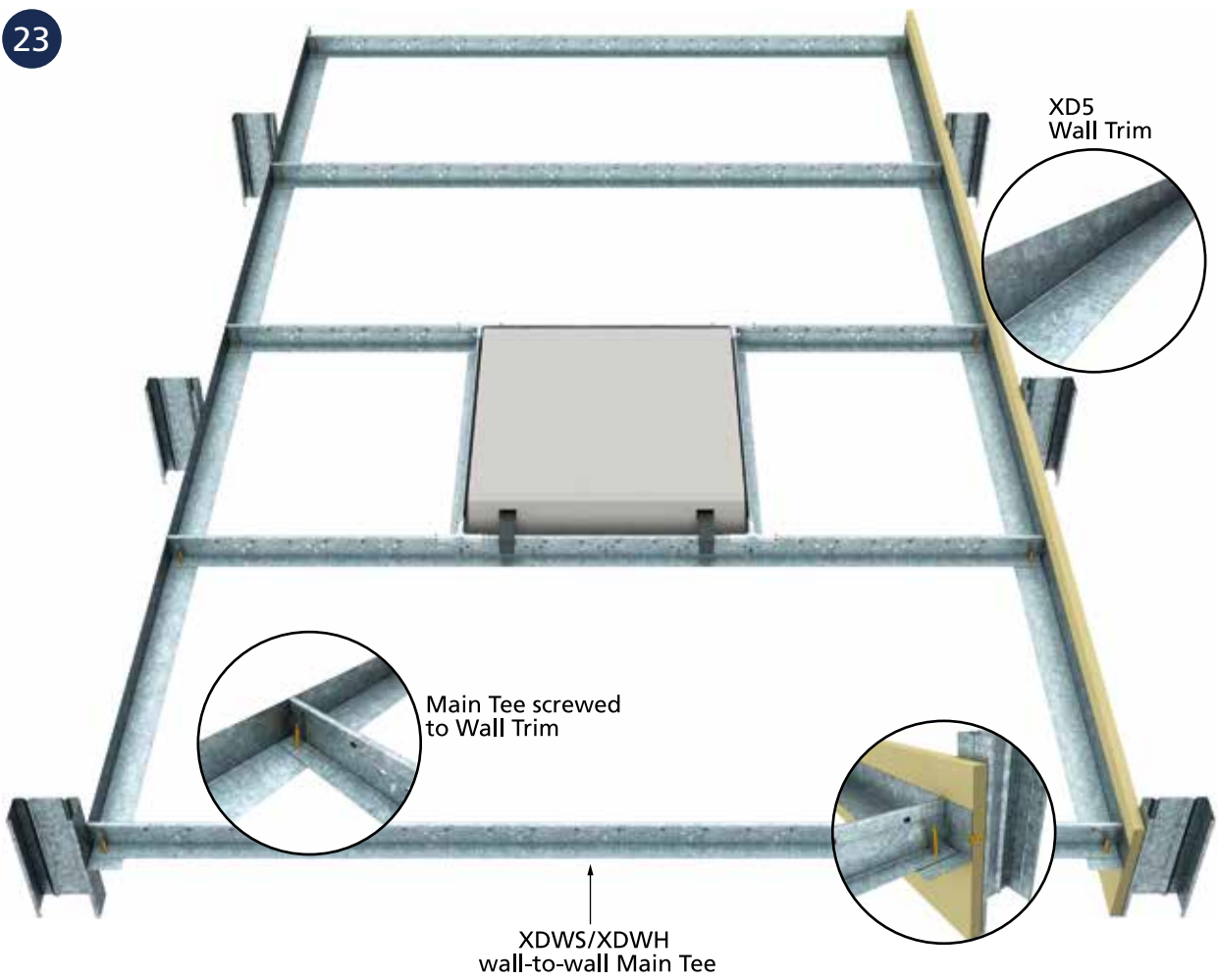

■ RONDO XPRESS® DRYWALL CORRIDOR: LIGHT FIXTURE APPLICATION

PRODUCT SPECIFICATIONS

	PART NO	LENGTH (mm)	HEIGHT (mm)	WIDTH (mm)	GAUGE (bmt)	FIRE RATED
	XDWS	1600	38	24	0.30	NO
	XDWH	2200	38	38	0.39	NO

LOAD TABLES

Maximum Spans: Corridor Ceilings

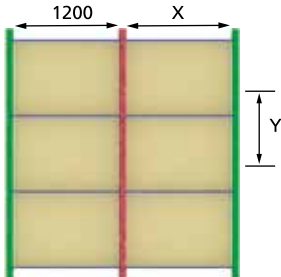
	Main Tee	Cross Tee	Cross Tee Length (X)	Spacing of Cross Tee (Y)	Main Tee Span				
					900	1050	1200		
					Allowable Load (kg/m ²)				
	XD1	XD2	1200	600	34.00	32.40	18.00		
				400	46.10	32.40	18.00		
			1250	600	29.20	29.20	17.10		
				400	44.00	30.90	17.10		
			1500	600	12.80	12.80	12.80		
				400	21.60	21.60	13.40		
			1600	600	9.00	9.00	9.00		
				400	16.00	16.00	12.30		
			1800	400	8.70	8.70	8.70		
				300	13.20	13.20	13.20		
			XD1H	XD2	1200	600	34.00	34.00	28.80
						400	53.40	42.80	28.80
1250	600	29.20			29.20	27.40			
	400	46.20			40.90	27.40			
1500	600	12.80			12.80	12.80			
	400	21.60			21.60	21.60			
1600	600	9.00			9.00	9.00			
	400	16.00			16.00	16.00			
1800	400	8.70			8.70	8.70			
	300	13.20			13.20	13.20			
XD3	XD2	1200			600	34.00	28.00	15.40	
					400	42.90	28.00	15.40	
		1250	600	29.20	26.70	14.60			
			400	41.00	26.70	14.60			
		1500	600	12.80	12.80	12.80			
			400	18.10	18.10	11.40			
		1600	600	9.00	9.00	9.00			
			400	16.00	16.00	10.30			
		1800	400	8.70	8.70	8.70			
			300	13.20	13.20	8.70			
		XD3H	XD2	1200	600	34.00	34.00	27.00	
					400	53.40	40.70	27.00	
1250	600			29.20	29.20	25.70			
	400			46.20	38.90	25.70			
1500	600			12.80	12.80	12.80			
	400			21.60	21.60	20.60			
1600	600			8.50	8.50	8.50			
	400			16.00	16.00	16.00			
1800	400			8.70	8.70	8.70			
	300			13.20	13.20	13.20			

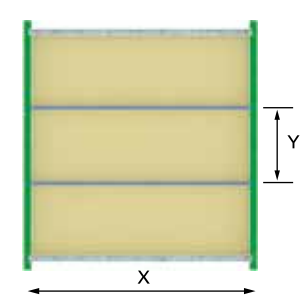

		X: Corridor Width (mm)			
		1500	1800	2000	2200
Cross Tee	Y Spacing (mm)	Allowable Load (kg/m ²)			
XDWS	400	21.40	8.50	–	–
	300	29.90	12.70	7.00	3.50
XDWH	600	20.20	8.30	4.30	–
	400	32.30	14.40	8.50	4.70
	300	44.30	20.60	12.60	7.50

NOTES:

1. The above tables provide the allowable lining weights that can be affixed to the ceiling grid. Accordingly, the above weights can be compared directly to manufacturers' published weight data as a means of checking the adequacy of the ceiling grid.
2. All load combinations, as per AS/NZS2785, considered in the preparation of the above tables. ULS: 1.4G + 1.7U SLS: G + U
3. Connections have been checked against the details on Page 8, and throughout this manual. Alternative suspension arrangements shall be referred to Rondo.
4. Deflection limited to L/360 unless noted otherwise.
5. Lining contribution has been ignored in the analysis of serviceability.
6. The above design tables assume the ceiling plenum is vented, such that there is no possibility of a differential pressure across the ceiling grid. Where the ceiling is forming a pressure seal to the plenum, reference should be made to AS/NZS1170.2 for internal pressures, and the ceiling checked using the Wind Loading Tables on Page 30.
7. Seismic designs for this ceiling grid will need to be referred to Rondo.
8. Cross Tee member sizes 1250mm and 1800mm are made to order.

BULKHEADS & BOXED SOFFITS

Typical Application Details

Rondo XPRESS® Drywall Grid System offers design flexibility, whereby installers can use the same ceiling components from the flat ceiling system to construct a bulkhead/soffit.

24

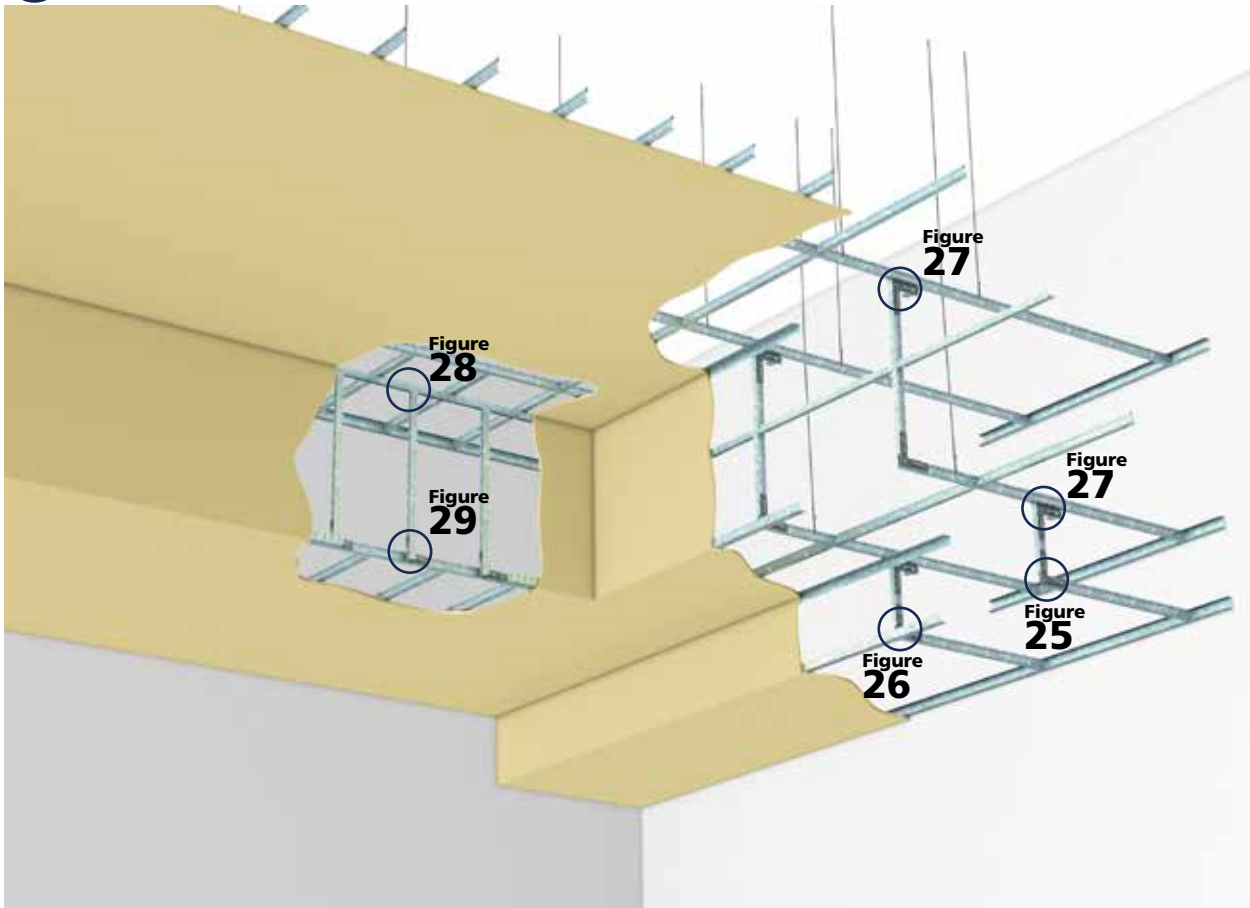

■ RONDO XPRESS® DRYWALL GRID BULKHEAD/SOFFIT

25

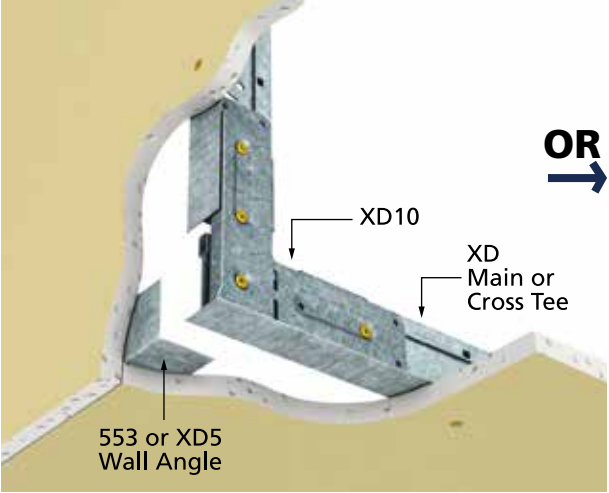

■ 90° OUTSIDE CORNER USING XD10

26

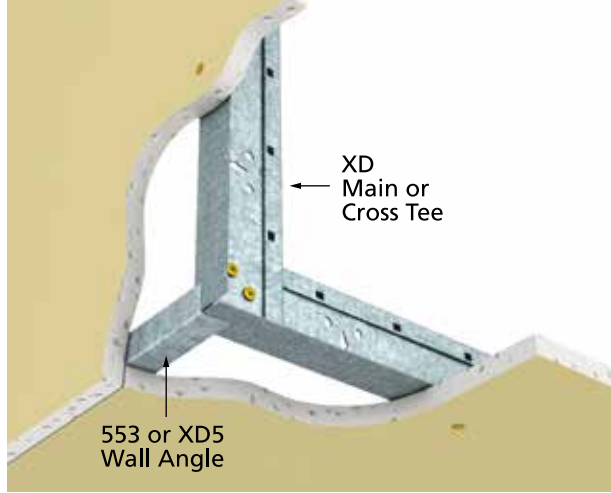

■ 90° OUTSIDE CORNER WITH CROSS TEE (ALTERNATIVE TO FIGURE 25)

27

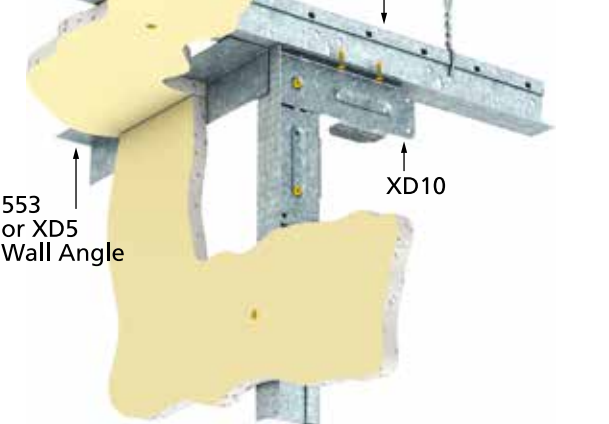

■ 90° INSIDE CORNER USING XD10

28

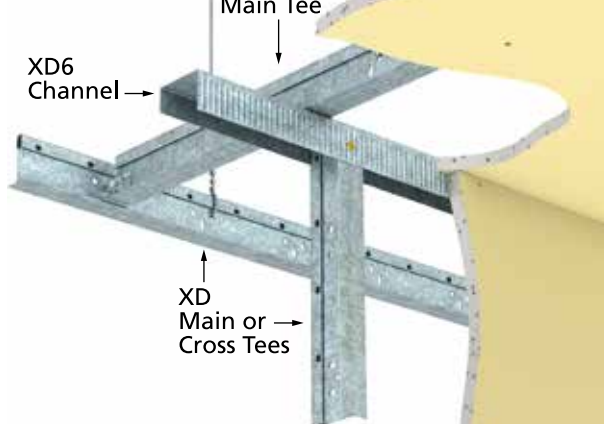

■ 90° INSIDE CORNER WITH WALL CHANNEL AT TOP EDGE

29

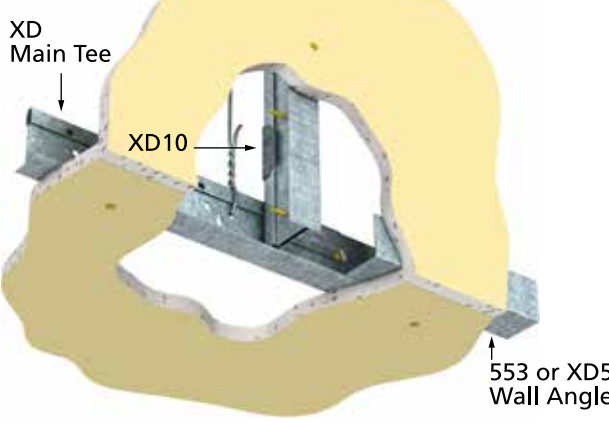

■ 90° OUTSIDE CORNER WITH MAIN TEE AT BOTTOM EDGE AND DETAIL

LIGHTING & ACCESS PANELS

Rondo XPRESS® Drywall Grid System is designed so that accommodating services such as light fittings and our PANTHER® Access Panels can be achieved simply.

30



■ TYPICAL RONDO XPRESS® DRYWALL GRID CEILING WITH LIGHT FIXTURE AND ACCESS PANEL

31

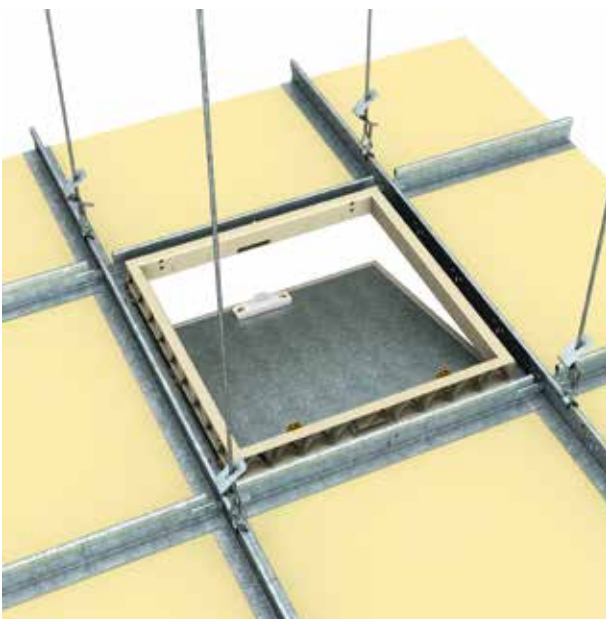

■ TYPICAL DETAIL: PANTHER® ACCESS PANEL

32

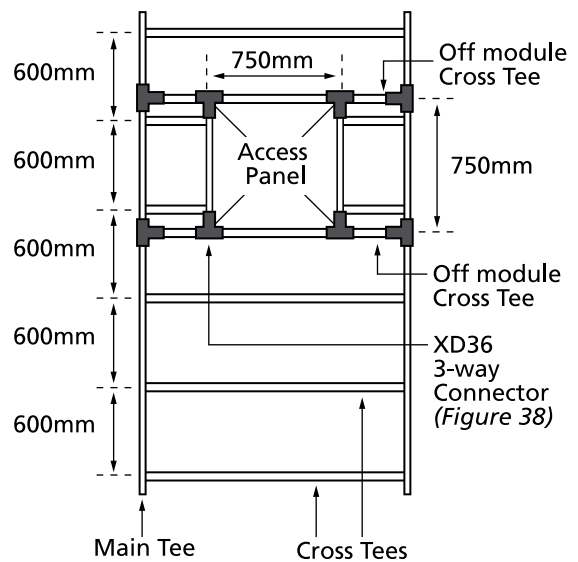

■ PANTHER® ACCESS PANEL OFF MODULE LAYOUT

Typical Application: Light Fixtures

LAY-IN LIGHT FIXTURE

A lay-in light fixture requires Main or Cross Tees to be located on either 600mm or 1200mm centres. The plasterboard is cut in line with the grid flanges and trimmed with Rondo EXANGLE® Stopping Beads.

The fixture is passed through the top of the opening and lowered to rest on the grid, followed by the diffuser to rest on the grid flange.

33

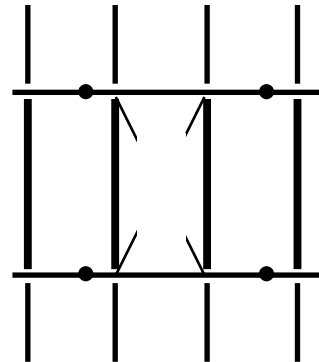

■ LAY-IN LIGHT FIXTURE MODULE

34

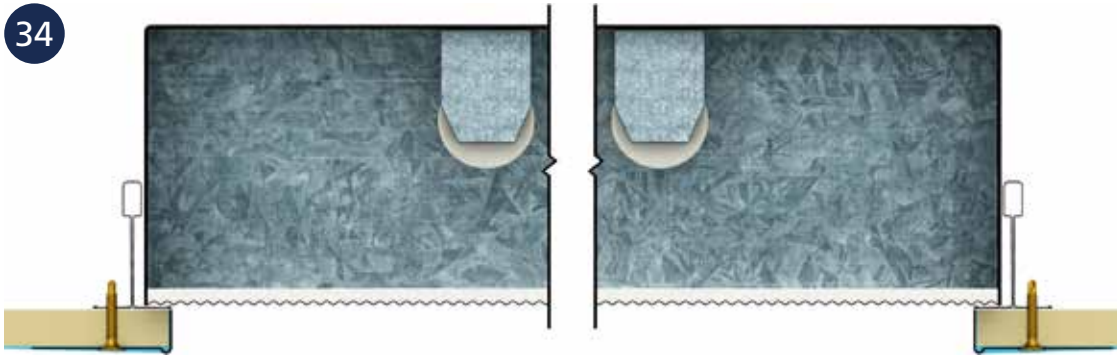

■ TYPICAL DETAIL: LAY-IN LIGHT FIXTURE

FRAMED LIGHT FIXTURE

Framed light fixtures have lower flanges that cover the cut edges of the plasterboard. This fixture typically requires a full 575mm or 1175mm opening, and therefore may require the 24mm faced optional utility Cross Tee.

Framed light fixtures are raised into the opening until the flanges contact the ceiling. Securing devices on the fixture are adjusted to suspend the fixture from the grid and pull it tight to the ceiling surface.

Where light fixtures are required to be positioned parallel with the main tee, 1200mm cross tees are punched at 300mm centres as standard to accept additional tees.

35

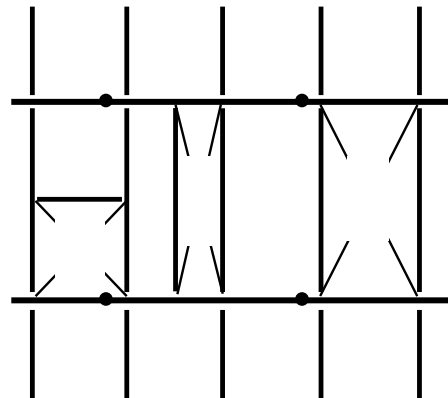

■ FRAMED LIGHT FIXTURE MODULE

36

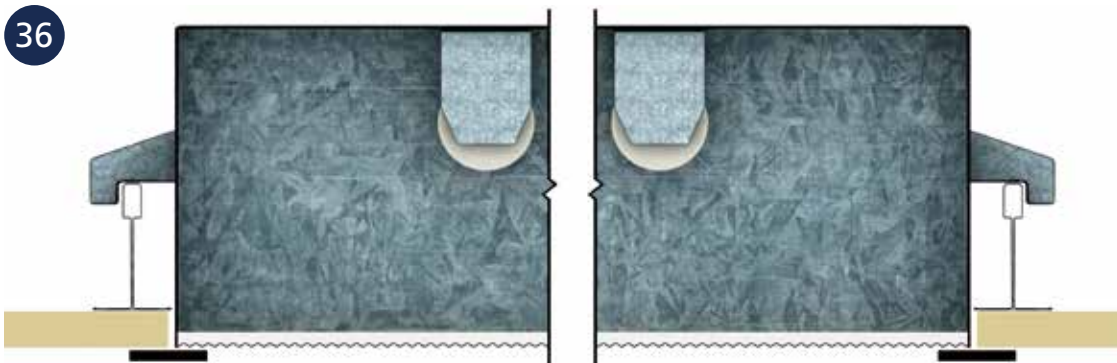

■ TYPICAL DETAIL: FRAMED LIGHT FIXTURE

OFF-MODULE GRID

37



■ TYPICAL APPLICATION: OFF-MODULE GRID ARRANGEMENT (SEE ALSO FIGURE 11 ON PAGE 13)

38

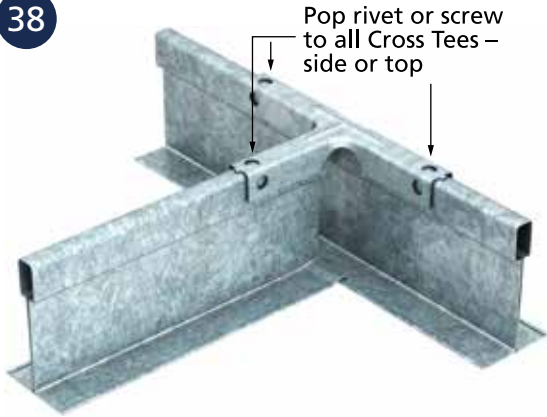

■ X-D36: 3-WAY OFF-MODULE CONNECTOR

Rondo X19 Strongback Clip (compatible with the 24mm Face Main Tee and Cross Tee)

Where utilities/services may need to be installed off-module, partial removal of the Rondo XPRESS® Drywall Grid and/or suspension hanger may be necessary.

To maintain strength and load carrying performance, it is necessary to reinforce the suspension system by following the details below.



■ XD19 STRONGBACK CLIP

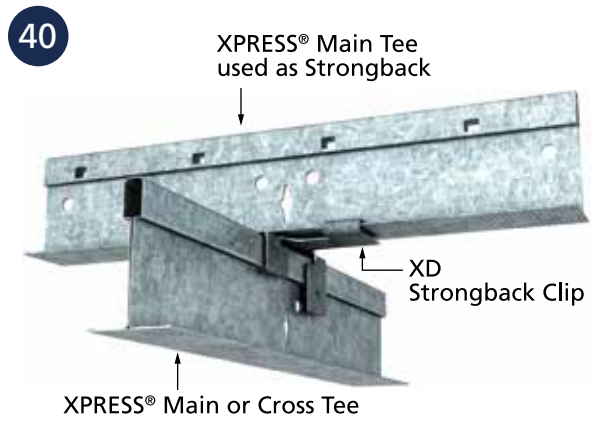

■ XD19 STRONGBACK CLIP INSTALLED

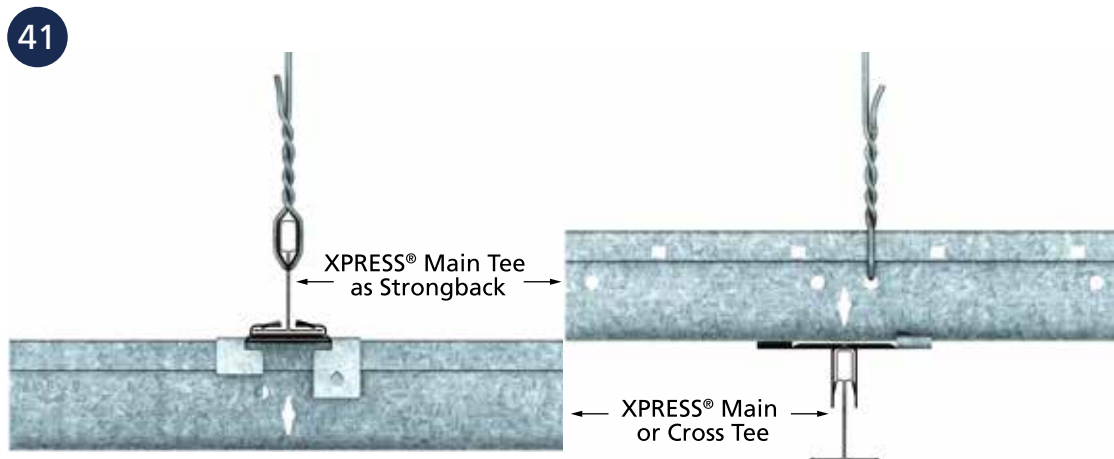

■ TYPICAL APPLICATION: STRONGBACK CLIP CONNECTION

OFF-MODULE GRID (continued)

Strongback Clip Details

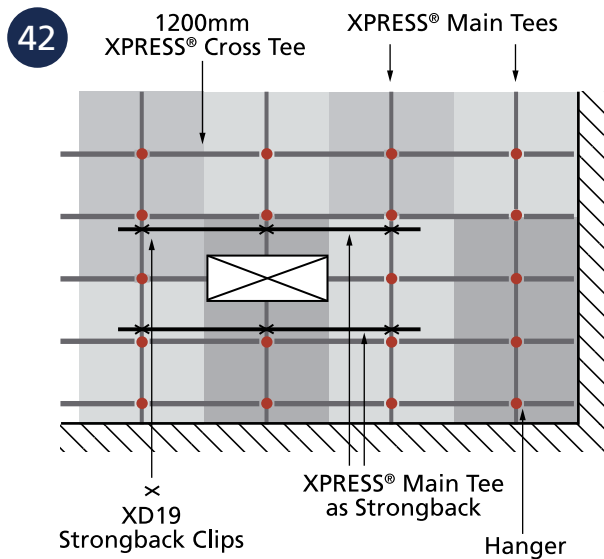

NOTE:

XPRESS® Strongback must span 2400mm minimum and use the XD19 clip at every intersection.

■ PLAN VIEW: REMOVAL OF ONE SUSPENSION HANGER

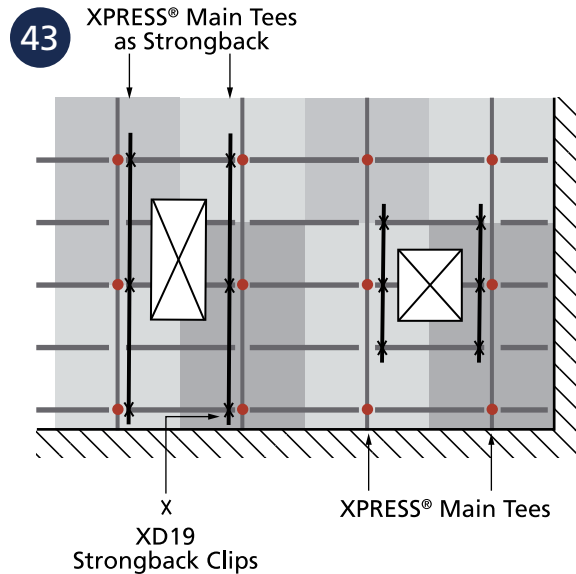

■ PLAN VIEW: PARTIAL REMOVAL OF A CROSS TEE

LIMITATIONS

The installation of Strongback Main Tees as shown **is not** suitable for:

- removing more than one ceiling support hanger, unless there is a minimum 4.0m clearance in any direction between any two hangers that are removed.
- supporting openings larger than 1200 x 600mm
- ceilings requiring a Level 5 finish (L/600).
- supporting services with a total weight heavier than 2.0kg on a ceiling with Level 4 finish (L/450). Services heavier than 2.0kg must be independently supported from the roof structure.
- supporting services with a total weight heavier than 5.0kg on a ceiling with Level 3 finish (L/360). Services heavier than 5.0kg must be independently supported from the roof structure.
- ceilings with face pressures greater than 40kg/m², considering the combination of dead load, services loads, and wind pressure with no load factors applied (i.e. serviceability limit state loads exceeding 0.4kPa.).
- ceilings that have been designed to resist seismic loads, refer to the notes alongside.
- exterior ceilings.

IMPORTANT NOTES

- 1) Caution must be used when installing Strongback Main Tees with XD19 clips in ceilings that are designed to resist seismic loads. Do not cut out and replace ceiling tees on any grid-line that has been fixed to a perimeter wall to restrain the ceiling under lateral seismic loads, or main tees on any gridline that is attached to seismic bracing in the plenum (unless the design engineer approves the specific installation).
- 2) The recommendations in this brochure have been established from the results of a full scale test. The actual strength and deflection of a ceiling will vary depending on the size of openings, continuity of main tee members, weight of supported services, weight distribution and fixing of supported services, and the quality of workmanship. These notes are a guide to the strength and level of finish that may be achieved, and do not constitute a guarantee of ceiling performance.

RONDO XPRESS® COMPLEMENTARY ACCESSORIES

The Rondo XPRESS® Drywall Grid Ceiling System includes a range of complementary accessories that are useful for a variety of applications.

- Transition Clip joints require at least one (1) hanger within 300mm.
- Splice Clip joints require one (1) hanger within 150mm of splice.
- Provide a hanger on Main and/or Cross Tee within 150mm of Fascia Clips.



The XD10 securely joins two tier grid components at a 90° angle. Bend down tabs secure the Clip to the grid. Screws provide a structural connection.

■ XD10 TRANSITION CLIP: OPTION 1

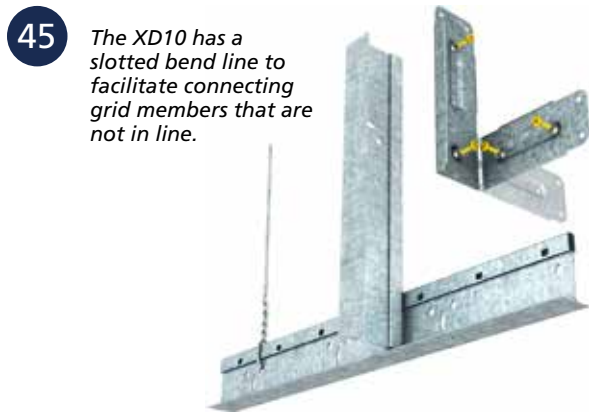

45 The XD10 has a slotted bend line to facilitate connecting grid members that are not in line.

■ XD10 TRANSITION CLIP: OPTION 2

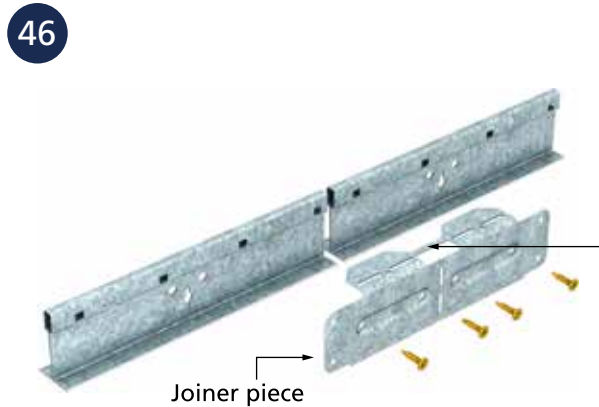

■ XDSC SPLICE CLIP: OPTION 1

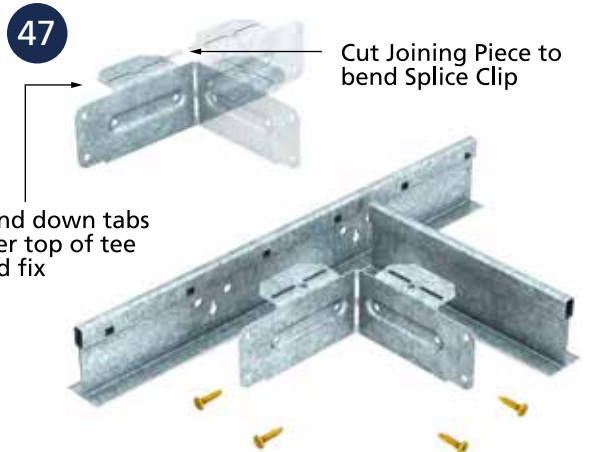

■ XDSC SPLICE CLIP: OPTION 2



48 These Clips are adjustable for both 13mm and 16mm boards. The two portions of the Clip are pivoted to accommodate fascia panels at any angle in relation to the grid.

XD12 x 100mm
XD13 x 150mm
XD14 x 200mm

■ FASCIA TRIM CLIPS & TYPICAL APPLICATION

Fascia parallel to Main or Cross Tee

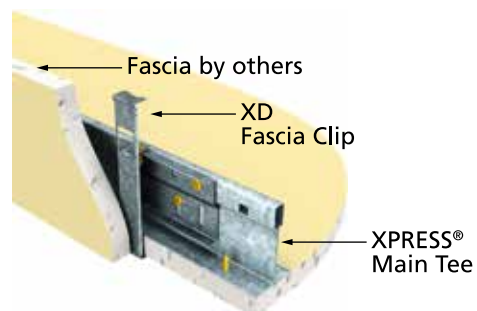

WIND LOADING TABLES

The Rondo XPRESS® Drywall Grid System has been engineered and designed for uplift resistance, as shown below. There are different grid and wind load combinations to accommodate design requirements and the below chart indicates the components, their spacing, strut options and allowable plenum depths which are necessary to achieve the different uplift classifications. Speak with your local Rondo office for applications not covered below.

Design wind loads vary with geographic region and building conditions, and must be established by a professional engineer or architect in accordance with AS/NZS1170.2.

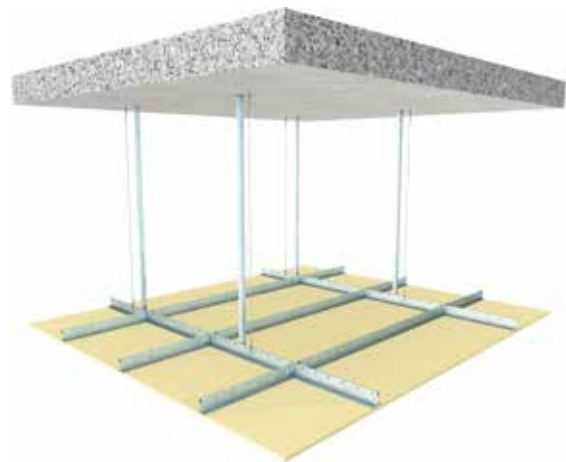

A	Main Tee	Cross Tee	Cross Tee Length	Spacing of Cross Tee	Main Tee Span		
					900	1050	1200
					Allowable Load (kPa)		
	XD1	XD2	1200	600	0.32	0.31	0.17
				400	0.39	0.31	0.16
		XD4	1200	600	0.27	0.27	0.17
				400	0.39	0.31	0.16
	XD1H	XD2	1200	600	0.32	0.32	0.31
				400	0.54	0.50	0.31
		XD4	1200	600	0.27	0.27	0.27
				400	0.46	0.46	0.31
	XD3	XD2	1200	600	0.32	0.30	0.13
				400	0.39	0.30	0.13
		XD4	1200	600	0.27	0.27	0.13
				400	0.39	0.30	0.13
XD3H	XD2	1200	600	0.32	0.32	0.29	
			400	0.54	0.47	0.29	
	XD4	1200	600	0.27	0.27	0.27	
			400	0.46	0.46	0.29	

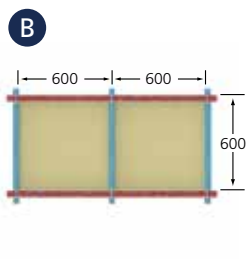
	Main Tee	Cross Tee	Cross Tee Length	Spacing of Cross Tee	Main Tee Span		
					900	1050	1200
					Allowable Load (kPa)		
XD1	XD4	600	600	0.90	0.75	0.48	
XD1H	XD4	600	600	1.42	1.16	0.77	
XD3	XD4	600	600	0.90	0.75	0.41	
XD3H	XD4	600	600	1.42	1.10	0.72	

NOTES:

1. The nominated pressure is the Ultimate Net Design Pressure, calculated in accordance with AS/NZS1170.2. Dead load does not have to be included in this pressure.
2. The design table has an allowance for ceiling linings up to 8.5kg/m². Where the linings exceed this weight refer to Rondo for confirmation.
3. The nominated pressure maybe positive (uplift) or negative (suction).
4. Deflection limited to L/200 under service wind load.
5. Design pressures have been checked assuming downstrutting on a 1200mm x 1200mm grid for Table A and a 1200mm x 600mm grid for Table B.
6. Maximum plenum depth not to exceed 1000mm. If plenum depth exceeds 1000mm, refer to Rondo for a solution.
7. Ceiling linings have not been checked in the above table and therefore remain the responsibility of the manufacturer.

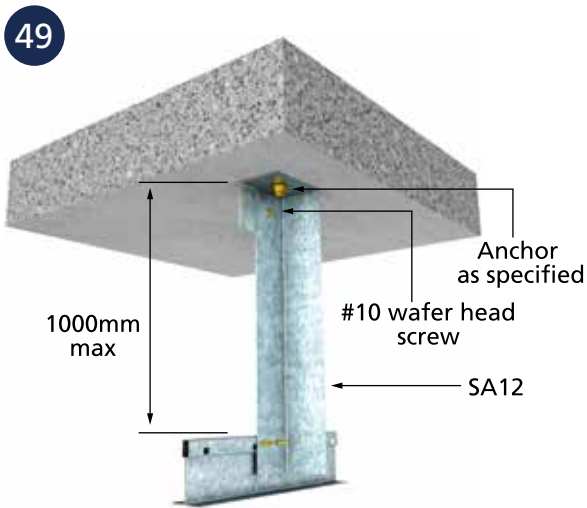

■ DOWNSTRUT DETAIL



■ SA12 SECURED TO WEB

RONDO OFFICES

AUSTRALIA

RONDO BUILDING SERVICES PTY LTD

CUSTOMER SERVICE HOTLINE:

1300-36-RONDO (1300-36-7663)

enquiries: rondo@rondo.com.au

NEW SOUTH WALES (HEAD OFFICE)

57-87 Lockwood Road, Erskine Park NSW 2759
(PO Box 324 St Marys NSW 1790)

enquiries: nsw@rondo.com.au
orders.nsw@rondo.com.au

phone: 61-2-9912 7300

VICTORIA

1 Columbia Court, Dandenong South VIC 3175
(PO Box 4458 Dandenong South, VIC 3164)

enquiries: vic@rondo.com.au
orders.vic@rondo.com.au

phone: 61-3-8561 2222

QUEENSLAND

13 Binary Street, Yatala QLD 4207
(PO Box 6006 Yatala QLD 4207)

enquiries: qld@rondo.com.au
orders.qld@rondo.com.au

phone: 61-7-3442 6400

SOUTH AUSTRALIA

39 George Street,
Green Fields SA 5107

enquiries: sa@rondo.com.au
orders.sa@rondo.com.au

phone: 61-8-8256 5900

WESTERN AUSTRALIA

15 Glassford Road, Kewdale WA 6105
(PO Box 168 Cloverdale WA 6985)

enquiries: wa@rondo.com.au
orders.wa@rondo.com.au

phone: 61-8-9251 9400

EXPORT

phone: 60-1-2386 1860

enquiries: export@rondo.com.au

www.rondo.com.au

NEW ZEALAND

RONDO BUILDING SERVICES PTY LTD

FREE CALL: 0800-0800-RONDO (0800-0800-76)

AUCKLAND

1/118 Savill Drive
Mangere East Auckland 2024
(PO Box 12464 Penrose Auckland 1642)

enquiries:
rondo.newzealand@rondo.co.nz

phone: 64-9-636 5110

CHRISTCHURCH

106 F Carmen Road, Hornby Christchurch 8042
www.rondo.co.nz

MALAYSIA

RONDO METAL SYSTEMS SDN BHD

Lot 606, off Jalan SS13/1K,
47500 Subang Jaya Selangor
www.rondo.asia

enquiries:
rondo.malaysia@rondo.com.my

phone: 60-3-5614-9888

UAE

RONDO METAL PRODUCTS SDN BHD

Office 2302, Bayswater Tower, Business Bay
Dubai UAE
(PO Box 14424 Dubai UAE)
www.rondo.asia

phone: 971-4-2947959

INDIA

RONDO METAL SYSTEMS PVT LTD

www.rondo.asia

enquiries:
rondo.india@rondo.co.in

phone: 91-22-6500 0431

**QUICKER TO INSTALL.
AND SOON, QUICKER
TO DESIGN.**



**THE NEW
RONDO XPRESS®
DESIGN WIZARDS.**

www.rondo.com.au/express
www.rondo.co.nz/express

RONDO®



we're behind the best buildings