



**ACCESS PANELS**

# RONDO PANTHER® ACCESS PANELS

## SUMMARY

The Rondo PANTHER® range of access panels and frames have been rigorously tested for quality and performance with respect to relevant fire or acoustic ratings. The standard Sound Rated Access Panels come with a unique polymer frame, which can be temporarily secured through the face of the frame (yes, even the flanged version) for faster and safer fixing. They are also around 30% lighter which is a big plus for an installer.

The contractor has a range of standard or customer sizes to choose from, as well as a choice of locks, hinges and finishes to meet their design needs.

## SUITABLE FOR:

- Sound Rated Applications ( $R_w$  30)
- 1 and 2 Hour Fire Applications
- Tiled Access Options

## SPECIAL FEATURES

- Standard Sound Rated panels made with a unique polymer frame; 30% lighter
- Selection of surround finishes (Flanged or Set Bead)
- Wide Variety of Locks: key budget lock, numbered key cam, or concealed touch lock
- Five Standard Sizes
- Standard Sound Rated Panels can be face fixed initially, to achieve faster and safer installation
- Sound-Rated and 1 hour Fire-Rated panels over 450mm size are supplied with a safety chain

## IN PRACTICE

Many leading projects have benefited from using Rondo PANTHER® Access Panels, including the multimillion dollar serviced apartment complex, *C2 Esplanade in Darwin* and the Five-Star Green Star rated *400 George Street office building in Brisbane*.

## IMPORTANT NOTE:

Rondo recommends its products and systems are installed by a qualified tradesperson and according to the relevant codes and standards outlined on page [256](#) of this manual.

### IMPORTANT

**Our Fire-Rated Access Panels have been tested and approved for use in Ceiling applications only. They are not to be installed in walls**

## CONTENTS:

ACCESS PANELS [214](#)

INSTALLATION DETAILS:

- METAL FACED ACCESS PANELS [215](#)
- SOUND RATED ACCESS PANELS [216](#)
- FIRE RATED ACCESS PANELS [217](#)

TILE ACCESS PANEL [218](#)

HARDWARE OPTIONS [219](#)

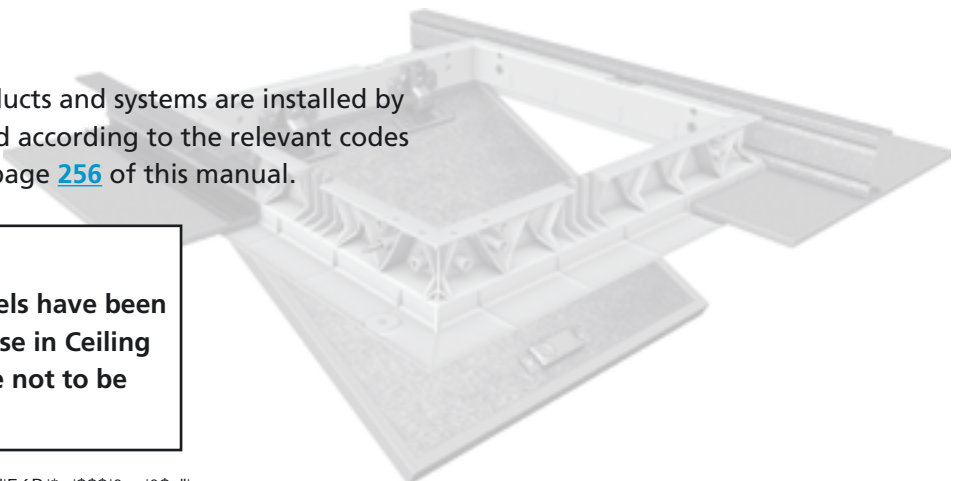

# ACCESS PANELS

## METAL FACED

|         |  |
|---------|--|
| MFAP FE | Slimline Metal-face door – Flanged: 300x300/450x450/550x550/600x600  |
| MFAP SB | Slimline Metal-face door – Set Bead: 300x300/450x450/550x550/600x600 |

## METAL FACED



MFAP FLANGED



MFAP SET BEAD

## SOUND RATED

|         |  |
|---------|--|
| SRAP FE | Sound rated, polymer frame – Flanged: 300x300/450x450/530x530  |
| SRAP SB | Sound rated, polymer frame – Set Bead: 300x300/450x450/530x530 |

## SOUND RATED

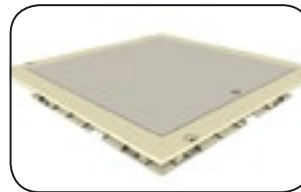

SRAP FLANGED

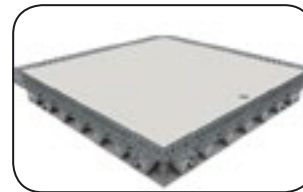

SRAP SET BEAD

## FIRE RATED FOR CEILINGS

|           |   |
|-----------|---|
| FRAP1H FE | 1 hour fire rated – Flanged: 300x300/450x450/530x530/600x600  |
| FRAP1H SB | 1 hour fire rated – Set Bead: 300x300/450x450/530x530/600x600 |
| FRAP2H FE | 2 hour fire rated – Flanged: 300x300/450x450/530x530/600x600  |
| FRAP2H SB | 2 hour fire rated – Set Bead: 300x300/450x450/530x530/600x600 |

## FIRE RATED FOR CEILINGS

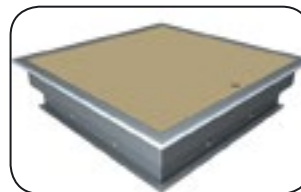

FRAP 1HR FLANGED

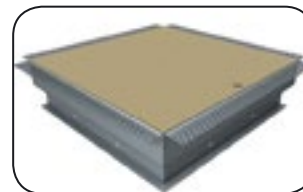

FRAP 1HR SET BEAD

## ALUMINIUM MANHOLE FRAME

|         |  |
|---------|--|
| AMF3030 | White aluminium manhole frame: 300x300/450x450/550x550/600x600 |
|---------|--|

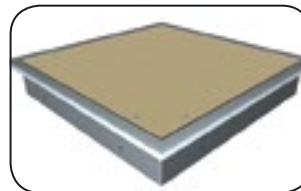

FRAP 2HR FLANGED

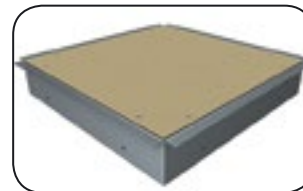

FRAP 2HR SET BEAD

## MADE TO ORDER:

### TILE ACCESS PANEL

|      |                           |
|------|---------------------------|
| SPTP | Special Tile Access Panel |
|------|---------------------------|

## ALUMINIUM MANHOLE FRAMES

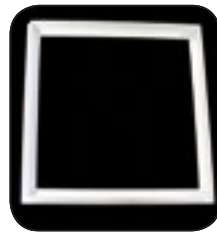

AMF3030

## NOTE

Metal Faced, Sound Rated and Fire Rated Access Panels are also available in other custom sizes and made to order. However, frame material and some depth dimensions may vary from the standard product. Contact your local Rondo Sales Office for more details.

## TILE ACCESS PANEL



SPTP

# INSTALLATION DETAILS

## Metal Faced Access Panels

### STEP ONE

Cut a hole in the lining board to match panel size as marked on box adding 5mm each side to allow for clearance (refer to Figure 1).

### STEP TWO

Trim around the opening using 64mm steel studs, screw fixed to the plasterboard.

### STEP THREE

Bend the metal fixings tags, located around the inside of the frame, to the vertical position and insert the panel into the opening.

### STEP FOUR

Screw fix through the tags into the support framing. Ensure the support framing is securely fixed to the ceiling grid.

### STEP FIVE

Finish as required.

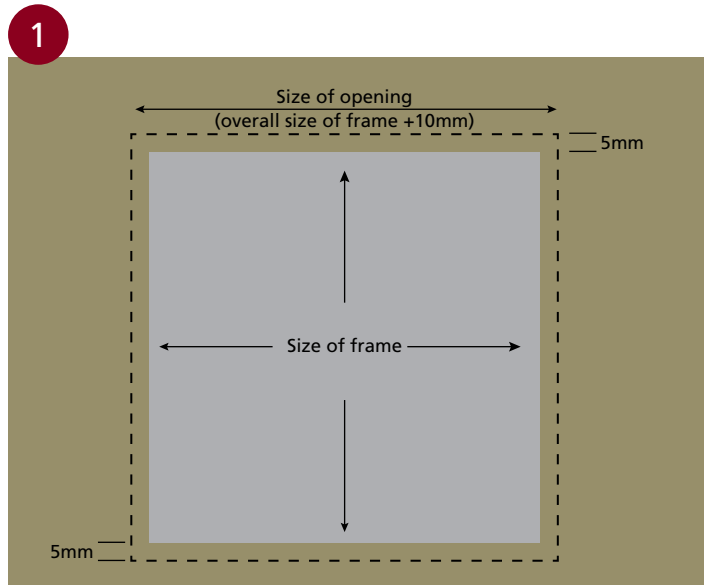

■ CUTTING HOLE IN LINING BOARD

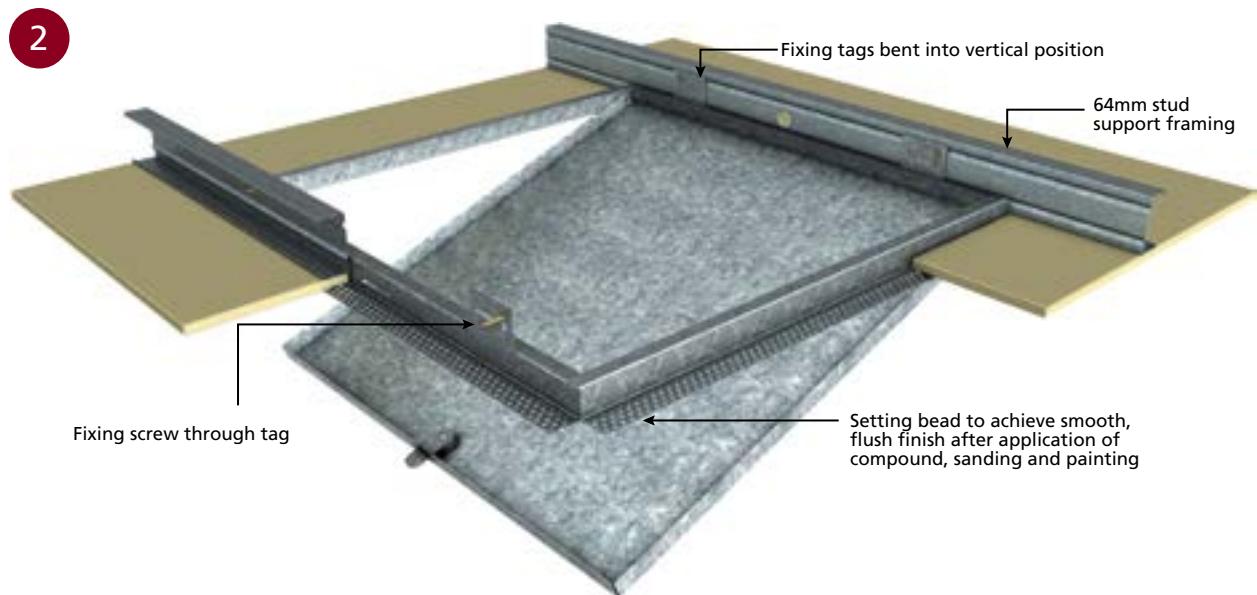

■ MFAP INSTALLATION

# INSTALLATION DETAILS (continued)

## Sound Rated Access Panels

### STEP ONE

Cut a hole in the lining board to match panel size as marked on box adding 5mm each side to allow for clearance (refer to Figure 1).

### STEP TWO

Trim around the opening using 64mm steel studs, screw fixed to the plasterboard.

### STEP THREE

Without opening the door screw fix the panel to the framing via the pre-formed countersunk holes in the surrounding bead or flange.

NOTE: Ensure support framing is installed so it is an integral part of the ceiling framing and if necessary install additional ceiling hangers.

### STEP FOUR

Open the door and install the security screws through the inside of the frame.

### STEP FIVE

A bead of appropriate sealant should be applied around the frame before insertion into the opening.

### STEP SIX

Install safety chain, if supplied.

### STEP SEVEN

Finish as required.

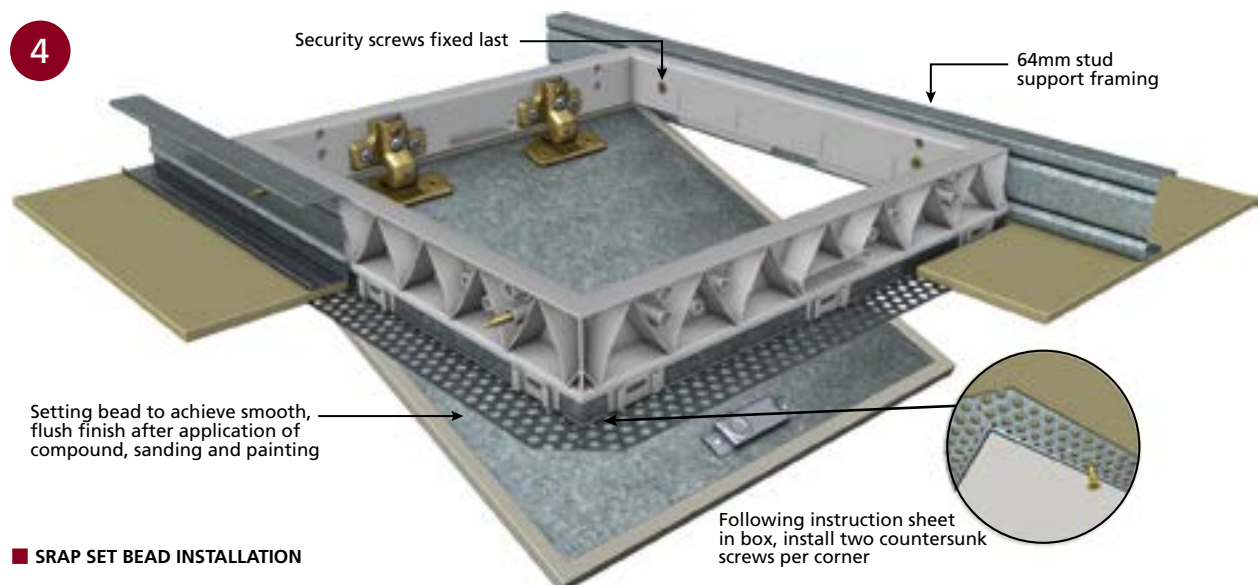
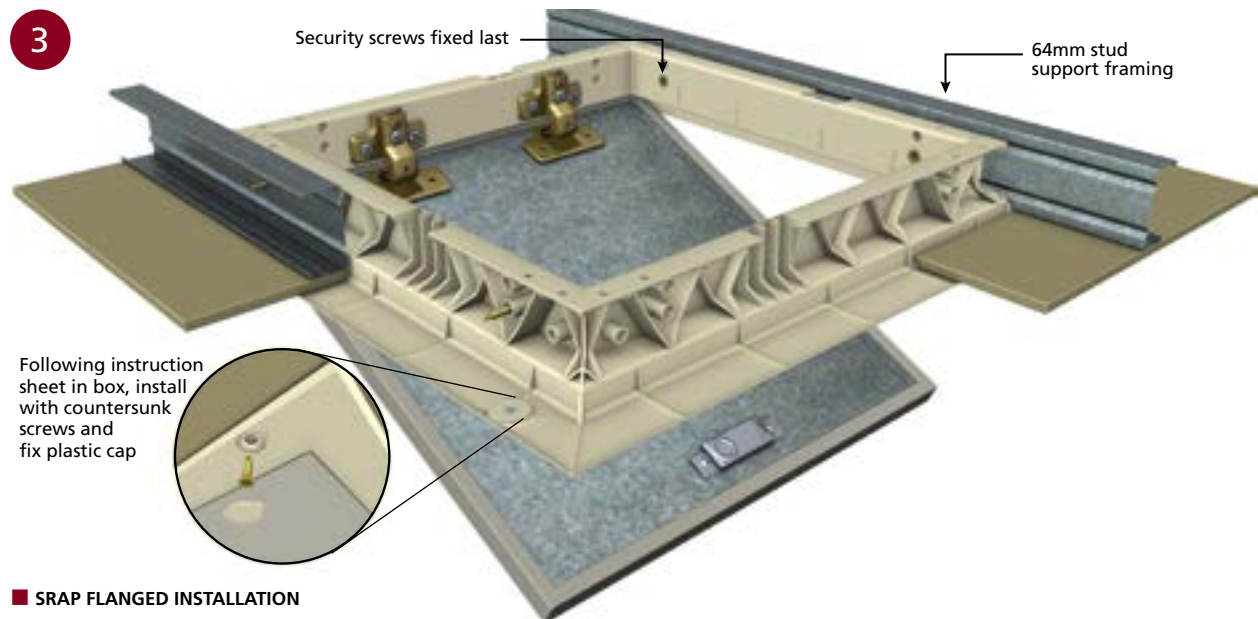



## Fire Rated Access Panels

### STEP ONE

Cut a hole in the lining board to match panel size as marked on box adding 5mm each side to allow for clearance (refer to Figure 1).

### STEP TWO

As these panels are heavy, use minimum 76mm stud as support framing so the frame becomes an integral part of the ceiling framework.

NOTE: If necessary install additional ceiling hangers to add support to the ceiling framing.

### STEP THREE

Secure the panels by installing fixings screws through the inner face of the frame into the support using a minimum of 2 screws per side to all 4 sides.

### STEP FOUR

Fire resistant caulking material should always be applied around the perimeters of these frames as illustrated.

### STEP FIVE

Install safety chain, if supplied.

### STEP SIX

Finish as required.

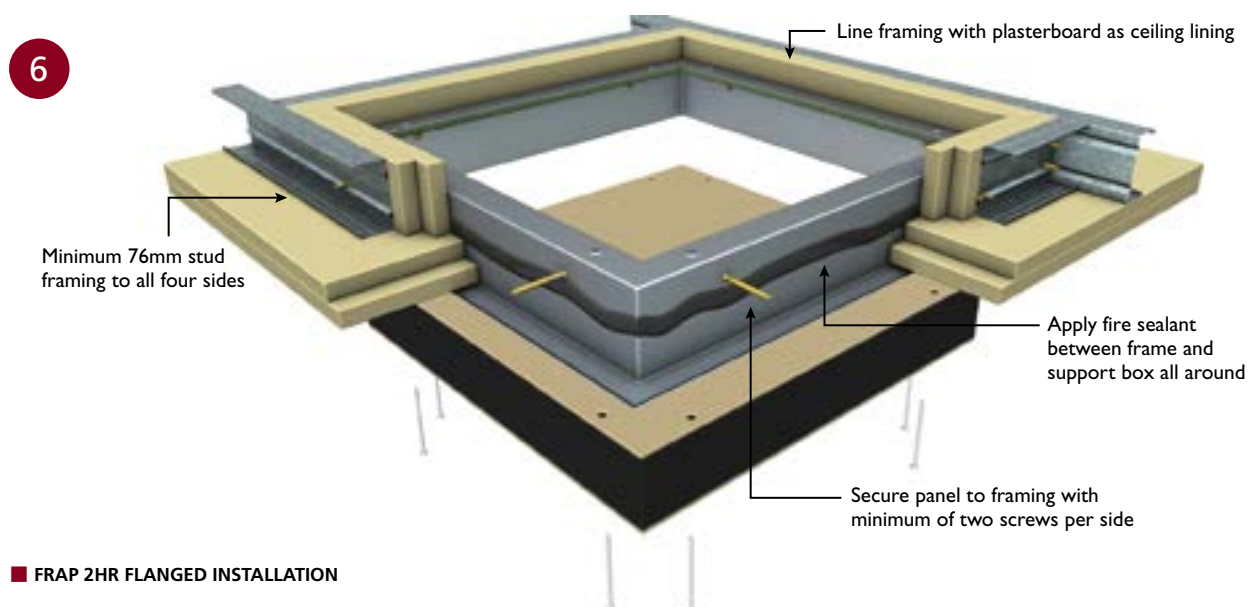
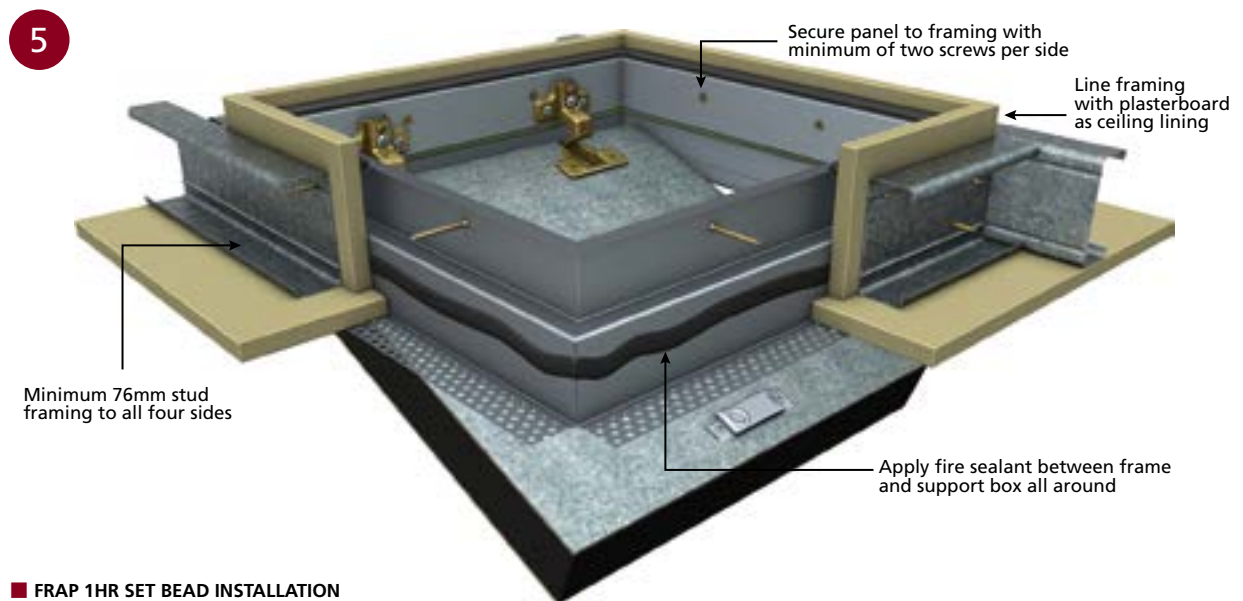

# TILE ACCESS PANEL

An access panel designed for a ceramic tiled or panelled wall where access may be required to service plumbing works in the event of leaks, etc. or other concealed services.

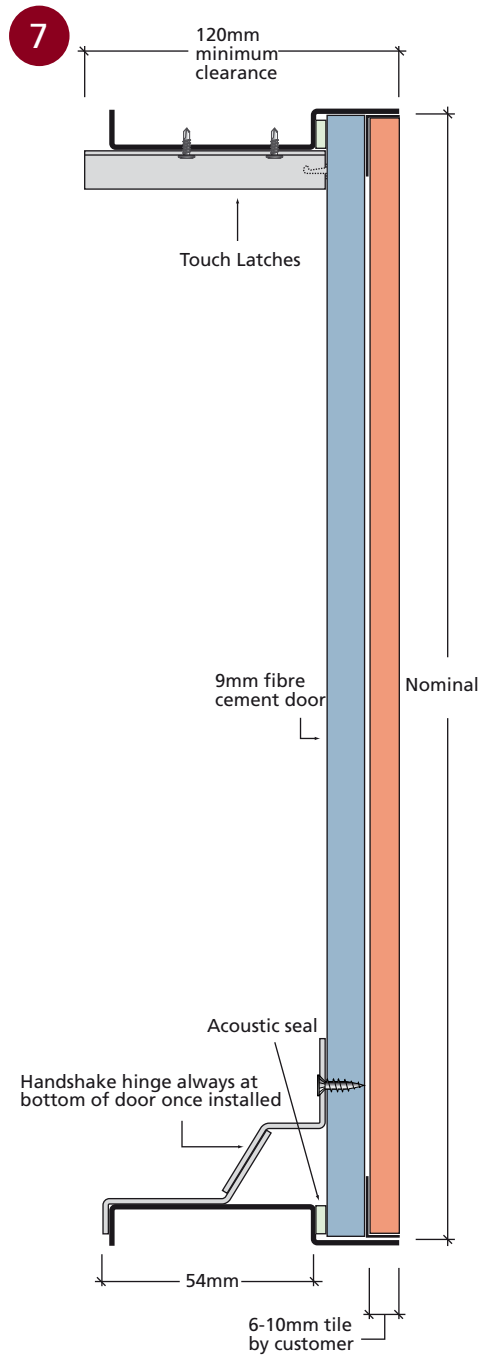

■ INSTALLATION DETAIL



|                        |  |
|------------------------|--|
| <b>APPLICATION</b>     | Walls only, 6mm or 10mm deep tile  |
| <b>PROFILE</b>         | Standard Profile 76mm deep (this panel can also be manufactured with a frame depth of 21mm – Budget Lock only) |
| <b>PANEL FRAME</b>     | Precision manufactured from 1mm galvanised steel   |
| <b>PANEL DOOR</b>      | 9mm CFC with a 0.40mm galvanised backing sheet   |
| <b>LOCKS</b>           | Touch Lock only (Touch Lock cannot exceed 600 <sup>2</sup> )   |
| <b>SAFETY FEATURES</b> | Identification, safety chains and safety labels attached to the inside of the door                             |
| <b>STANDARD SIZES</b>  | There are no standard sizes in this panel. All Tile Panels are made to order.                                  |

## IMPORTANT INFORMATION:

Hinge arrangement is always placed at bottom of penetration, not at side. (i.e. 450H x 600W 10mm tile panel will have the hinge on the 600 dimension.) This prevents the panel from falling out of the wall, due to the fact that the locks are at the top of the panel and hinges are always at the bottom of the panel.

When nominating a panel for tiling:

1. If a panel 300mm square is nominated, this is overall frame size, therefore tile must be trimmed.
2. If a 300mm square tile is not to be cut, then an overall panel of 307mm square is required. This allows the tile to fit within the steel trim, but the overall panel will be in line with outside of grout lines.

# HARDWARE OPTIONS

## BUDGET LOCK

Standard lock for MFAP, SRAP & 1 Hour FRAP (Note: FRAP & SRAP square key lock back sealed)



■ SQUARE KEY BUDGET LOCK

## CAM LOCK\*

Alternative keyed lock for SRAP Panels only, two keys supplied per panel, all panels are supplied keyed alike or can be supplied with differing keyed barrels.



■ NUMBERED KEY CAM LOCK

## TOUCH LATCH\*

Supplied for MFAP & SRAP panels only and up to 450x450 size only. Panels have two latches for added security.



■ CONCEALED TOUCH LATCH

## MAGNETIC CATCH\*

Supplied for SRAP 300 x 300, 450 x 450, and 530 x 530 sized panels only.

By placing the magnetic key beneath the lock, the latch is released and the door will open. Removing the key allows the latch to spring back and the door is closed by simply pushing it into position until it 'clicks' closed.

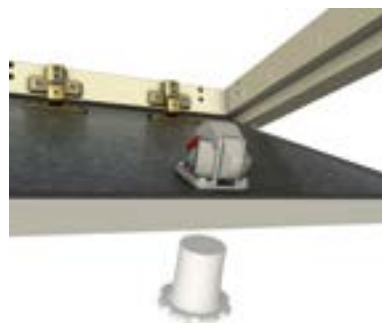

■ MAGNETIC CATCH

## NOTE

Rondo also supplies a range of special panels that are suitable for high security institutions, hospitals, and lift motor room access. Enquiries on Rondo special panels can be made to a Rondo Sales Office.

\* These locks are supplied by order, requiring lead times, and are at an additional cost.